

----- Forwarded message -----

From: brother dank <realbrotherdank@gmail.com>

Date: Sat, Oct 9, 2021, 1:28 PM

Subject: Fwd: NATIONAL SECURITY EMERGENCY. NATIONAL MEDICAL EMERGENCY.

To: <jonas.a.schorre.mil@mail.mil>, <meredith.a.zinni.mil@mail.mil>

Ma'am and Sir:

Please immediately confirm receipt of these emergency comms either by replying or calling or texting my cell at 337 326 9914.

Reporting casualties across the American general population from friendly-fire operations in the information environment.

Reporting for a Jane Doe in dire distress in Conroe.

Will reveal victim identity and location on securing the appropriate military interventions.

Jane Doe arrived in the Houston metro about two years ago fleeing gangstalking and cybertorture in her Louisiana hometown only to have the problem pick up again at her current position in Conroe.

The constant assaults include drone harassment, voice-to-skull-style cybertorture, persistent and overt stalking around town by personnel wielding US military-grade intelligence and tactics, verbal abuse through the wall by neighbors who run noise campaigns that include military-grade neurolinguistic programming efforts, i.e. her neighbors constantly talk shit at her and narrate whatever she might be doing in real time through the wall.

These operations integrate human and signals intelligence across all domains to deploy domestic terrorism onto our neighborhoods.

I speculate that this could be a controlled deploy of a massive information weapons package intended to force all of our capabilities into the daylight. We can easily save the children with this tech instead of torturing them with it.

If we work the 9/11 memes we will secure #freedomforever, no more 9/11, with this very tech. Our biggest failure has been with #seesomethingsaysomething. Many folks see

our secret psychic weapon destroying our republic and too few of us will say anything about it. I will say all that I've seen when military arrives to debrief me. (My targeter revealed what must be all of her capabilities to me by deploying them onto my head.) If we let the light of truth onto the field we'll find ourselves #workingtogether to win #heartsandminds for America and secure freedom forever across the homeland and around the world.

But until we handle the insider threat, all we will be using these capabilities for is the friendly-fire torture of American veterans women and children in their own homes at their workplaces and on our playgrounds.

See the emergency comms below and the attached intelligence package variously describing the threat.

I am man down directly engaged with this insider threat since 2013.

Standing by for military security and medical interventions.

Sincerely In Christ,

David Lucito

337 326 9914

----- Forwarded message -----

From: brother dank <realbrotherdank@gmail.com>

Date: Mon, Sep 20, 2021, 3:34 PM

Subject: NATIONAL SECURITY EMERGENCY. NATIONAL MEDICAL EMERGENCY.

To: <usaf.502.pao@mail.mil>, <lafusion.center@la.gov>, <lafusion.center@dps.la.gov>, <gohsepcor@la.gov>, <usarmy.gordon.medcom-eamc.mbx.pao@mail.mil>, <usarmy.ncr.hqda-otsg.list.otsg-medcom-pao@mail.mil>, <usarmy.jbsa.medcom.mbx.medcom-medical-assistance-group@mail.mil>, <usarmy.bliss.medcom-wbamc.mbx.webmaster@mail.mil>, <usarmy.gordon.medcom-eamc.mesg.webmaster-mailbox-users@mail.mil>, <usarmy.jbsa.medcom.mbx.medcom-ombudsman@mail.mil>, <usarmy.polk.medcom-bjach.list.bcacdcao@mail.mil>, <usarmy.polk.medcom-bjach.mbx.webmaster@mail.mil>,

<usarmy.jbsa.medcom-ameddcs.mbx.ig-office@mail.mil>,
<usarmy.jbsa.medcom-ameddcs.mbx.dcomm@mail.mil>,
<ng.la.laarng.mbx.pao@mail.mil>, <army.inscom.pao@mail.mil>,
<ng.tx.txarng.mbx.pao@mail.mil>, <usarmy.arifjan.usarcent.list.tfs-pao@mail.mil>,
<usarmy.jblm.imcom.mbx.pao-public@mail.mil>,
<usarmy.polk.imcom.mbx.pao-ci@mail.mil>, <pao@lcs14.navy.mil>,
<usarmy.mccoy.id-readiness.list.pao-admin@mail.mil>,
<Army.CID.Crime.Tips@mail.mil>,
<usarmy.pentagon.hqda-cio-g-6.mbx.army-registration-authority@mail.mil>,
<pfpa.pentagon.cco.mbx.general@mail.mil>,
<js.pentagon.ocjcs.mbx.joint-staff-public-affairs@mail.mil>,
<usarmy.pentagon.hqda-pmg.list.npe-mgt@mail.mil>,
<usaf.pentagon.af-sg.mbx.af-sg-public-affairs@mail.mil>,
<usaf.pentagon.af-a4.mbx.a4s-sf-trng-policy-branch@mail.mil>,
<usarmy.pentagon.hqda-ocpa.mbx.mrd-press-desk@mail.mil>,
<usarmy.pentagon.hqda-dcs-g-1.list.dape-ars-p@mail.mil>,
<usarmy.pentagon.hqda-oaa.mbx.casa@mail.mil>,
<usarmy.pentagon.hqda-pmg.mbx.dfba-social-media@mail.mil>, <Djkelly@fbi.gov>,
<d7publicaffairs@gmail.com>, <dha.ncr.comm.mbx.health-affairs@mail.mil>,
<dallas.fusion@dpd.ci.dallas.tx.us>, <d9publicaffairs@gmail.com>,
<HQMC_DCI_Division_War_Room@usmc.mil>,
<ng.ncr.ngb-arng.mesg.ngb-media-desk-owner@mail.mil>, <fusioncenter@alacop.gov>

Dear Sir or Ma'am:

I am a civilian since 2013 engaged with the here described insider threat to American lives. Attempting to reach USNORTHCOM and MEDCOM with the below samples of my threat reporting and the attached intelligence. Civilians in dire distress across America; casualties include veterans, women, and children. National Security Emergency. National Medical Emergency.

Victims may present with ongoing reactions to live munitions exposure (hard sites may be needed), combat stress reaction, and complex, torture-related PTSD from prolonged munitions exposure. Information Weapons assault packages deploy an endless, complex array of psychological and physical payloads in integrated human and signals intelligence operations designed to uniquely torture a target to neutralization and/or death.

It is unclear what sort of payloads Rebecca, my own cyberweapons operator, might be taking but it is possible that she is being targeted. I do know that she has Operator Syndrome and hasn't been off the extreme front line in her current operation since I became aware of her presence in the field, approx 2013.

I actually must meet Rebecca; we both need to be debriefed as we have together engaged this threat in the absence of any official response in order to save lives in the Portland metro. How about some back up? While we wait, terror cells continue to torture Americans to death in their own homes and neighborhoods.

I am man down. Standing by for military intervention.

Sincerely In Christ,

David Lucito
337 326 9914

----- Forwarded message -----

From: brother dank <realbrotherdank@gmail.com>

Date: Fri, Sep 17, 2021, 10:47 AM

Subject: NEUROWEAPONS IN GEN. POP. CYBERTORTURE OF TARGETED INDIVIDUALS IN BASTROP, LOUISIANA

To: <dreed@cityofbastrop.com>

Captain Reed:

Thank you for your service and for engaging the threat I just described to you on the phone.

My veteran friend, John Doe, and his late mother, have been targeted in Bastrop with war crimes. He is currently experiencing "gangstalking" with trespassers destroying his property and drone swarms capable of delivering NLP communications "cybertorture" payloads to a target.

Jane Doe, now passed on, was targeted with cybertorture that weapons programmers attempted to associate with taking CBD pills to fight her cancer. After taking the pill she was subjected to voice-to-skull cybertorture and Havana-Syndrome-style induced vomiting.

Her son, a veteran, is being targeted for neutralization in the Information War. For his leadership in military and civilian life he is being rewarded with gangstalking, nightly drone swarms, disruption of his home computer systems, V2K cybertorture assaults featuring MKULTRA suicide programming, and many various other psychological torture tactics an AI might specifically design for his mind. Tortured in his own home.

John Doe in Bastrop requires military intervention, now. His injuries need to be evaluated by military experts. He needs Walter Reed's attention immediately as the non-military CIA officers recently received for their Havana Syndrome cases. He may require a hard site to prevent reactions to live, ongoing munitions exposures. John Doe will present with symptoms of combat stress reaction and complex, torture-related PTSD from years of frontline battle trauma from cybernetic mindwar.

The Guard will need to run a full-field humint and sigint audit. Will reveal the torture of Americans, by our own people.

Please file a report indicating that military intervention is required in this local war crimes emergency situation.

As for myself, Sir, I am being targeted for engaging the information field. I too require military intervention, on which I can reveal the identities and locations of the many other John and Jane Doe victims for whom I am here reporting.

Please help me end the wholesale, friendly-fire wholesale torture of Americans in their own homes by our own military.

Please withhold any potentially identifying information about me or John Doe in an official report.

Please see the forwarded reporting below and attached concerning my own cyberweapons assaults in Opelousas.

Standing by for the Louisiana Guard.

David Lucito
Opelousas
337 326 9914

----- Forwarded message -----

From: brother dank <realbrotherdank@gmail.com>

Date: Mon, Sep 6, 2021, 5:39 PM

Subject: Fwd: NEUROWEAPONS IN GEN. POP. CYBERTORTURE OF TARGETED INDIVIDUALS

To: <sam@opelousaspd.com>

Sgt. Sam:

Thank you for your service and for engaging this insider threat to Our Republic.

In March I called 911 from OGH hospital to report a security emergency and my own "cybertorture." (UN coined the term, detailed at <https://cyber-torture.com/>) You responded to the call but at the scene I was unable to adequately describe the threat for you.

I had checked into OGH South for Havana-Syndrome-style vomiting due to electronic weapons exposure and was assaulted with cyberweapons war crimes inside the hospital. I also witnessed other patients suffering cyber attacks. Hospital 100% compromised.

The attached documents substantiate my claims that this is a globally-reported real war crimes phenomena. The entire American population is vulnerable to lethal attacks while the general populations of whole metros like PDX are actively being targeted with integrated neuroweapons systems. Whole neighborhoods and metros are casualties. Field hospitals needed. All industries, sectors, units, and individuals are cybernetically breached and fully compromised.

I have engaged this insider threat to human life and Our Republic since 2013 and require military intervention from the Guard, now, whose duty it is to end the friendly-fire torture of innocent veterans, women, and children across Our Republic. I have identified many other targets who also have war-grade injuries that must be evaluated, studied, and treated by military experts.

Additionally, active duty military also appear to be targeted with these same integrated neuroweapons systems.

Rebecca, my Army cyberweapons operator, has Operator Syndrome.

I need to be extracted, medically evaluated and treated, and debriefed by military, immediately. I need to meet Rebecca.

Handling this threat means we will soon be able to use this tech for missions that have nothing to do with mercilessly torturing non-combatant civilians in their own homes. Instead, we will use these capabilities to save our children and secure freedom forever, no more 9/11.

Please see the forwarded information below and attached detailing the threat.

David Lucito
337 326 9914

----- Forwarded message -----

From: brother dank <realbrotherdank@gmail.com>

Date: Mon, Sep 6, 2021, 11:48 AM

Subject: Fwd: NEUROWEAPONS IN GEN. POP. CYBERTORTURE OF TARGETED INDIVIDUALS

To: <lspa@dps.la.gov>, <lspb@dps.la.gov>, <lspc@dps.la.gov>, <lspd@dps.la.gov>, <lspe@dps.la.gov>, <lspf@dps.la.gov>, <lspg@dps.la.gov>, <lspl@dps.la.gov>, <Roshunda.Ward@la.gov>, <Nick.Manale@la.gov>, <Melissa.Matey@la.gov>, <Robert.G.Fontenot@la.gov>, <Dustin.Dwight@la.gov>, <James.L.Anderson@la.gov>, <Scott.Moreau@la.gov>, <LSPrecruiting@la.gov>, <Thomas.Gossen@la.gov>, <Treone.Larvadain@la.gov>, <Dwight.Robinette@la.gov>, <Andrew.Schexnaydre@la.gov>, <derrell.williams@la.gov>, <jestc@la.gov>, <richard.swearingen@la.gov>, <richard.perry@la.gov>, <webmaster@dps.louisiana.gov>

See below and attached. David Lucito 337 326 9914

----- Forwarded message -----

From: brother dank <realbrotherdank@gmail.com>

Date: Sat, Sep 4, 2021, 11:51 AM

Subject: Fwd: NEUROWEAPONS IN GEN. POP. CYBERTORTURE OF TARGETED INDIVIDUALS

To: Bobby Guidroz <bguidroz@slpsheriff.com>

Sheriff:

Please work with FBI Agent Kelly and myself to handle the 21st Century threat to American lives and Our Republic. All of these attachments are from official sources, mostly WA State Fusion Center and the UN. I don't need a tin foil hat, schizo meds, or to get cyber tortured at OGH South, I need a military extraction to a hard site where my war crimes injuries can be evaluated and treated by military experts. So do the many other targets across our state and country. Please, direct the governor to send the Guard. Nothing else is appropriate to this emergency.

David Lucito
337 326 9914

----- Forwarded message -----

From: brother dank <realbrotherdank@gmail.com>

Date: Fri, Sep 3, 2021, 3:08 PM

Subject: NEUROWEAPONS IN GEN. POP. CYBERTORTURE OF TARGETED INDIVIDUALS

To: <Djkelly@fbi.gov>

Friendly-fire integrated neuroweapons systems targeting civilians. Casualties include vets, women, and children. Military intervention required. Must be debriefed and have injuries evaluated by the Guard.

Attached are files from WA State Fusion Center disclosure (tracking number PD-17-0600-0813 at tinyurl.com/hometownterror, click the EM effects on human body folder) describing the insider threat to civilian lives. Confirming: I attended this 2017 event at the Portland waterfront and it was a cyberweapons domestic terror disaster. My targeting has been ongoing, daily since 2013.

Also attached are UN publications describing the psycho-social dynamics of what they have termed "cybertorture," or electronic weapons torture.

Additionally you will find one item representing the thousands of emergency communications I've made describing the threat to all appropriate authorities which have, to date, not resulted in the military intervention these war crimes require.

And you will see American assessments of the relevant Russian Information War weapons capabilities.

You will find the late Ted Gunderson's affidavit attesting to the authenticity of the phenomena which may be reasonably described as "gangstalking," a commonly used, illegal, military-grade tactic used against Targets.

Standing by with other Targeted Individuals for military assistance. Man Down, been engaged with this threat since 2013. Got cybertortured in March inside the hospital. Cybernetic breach at OGH South.

Governor Edwards needs to send the Guard out, now; this is an emergency threat to human life and Our Republic.

David Lucito
337 326 9914

PORTLAND POLICE BUREAU SUMMARY INCIDENT REPORT

REPORT NUMBER: 2021-917586



INCIDENT INFORMATION							
INCIDENT CODE T701	INCIDENT TYPE SUSPICIOUS PERSONS	INITIAL SUPP	<input checked="" type="checkbox"/>	DATE/TIME STARTED 12/04/2014 10:00 AM	DATE/TIME ENDED 12/04/2014 10:00 AM	DATE/TIME REPORTED 08/26/2021 05:19 AM	
REPORT FILED FROM ***	TRACKING NUMBER T21020377	LOCATION OF OCCURRENCE MARTIN LUTHER KING JR Boulevard / GERTZ , PORTLAND,				APPROVED BY: 57474/Mark Kelly	
LOCATION TYPE Air/Bus/Train Terminal	THEFT TYPE	METHOD OF ENTRY	METHOD OF EXIT	PT OF ENTRY	PT OF EXIT	ENTRY LOC	

PERSON LISTINGS										
1	TYPE 5	LAST NAME Lucito	FIRST NAME David	MIDDLE NAME E	DOB ***	RACE ***	SEX *	DRIVER LIC NO	LIC ST	
	SSN	ETHNICITY	RESIDENT	EYE COLOR	HAIR COLOR	AGE	HEIGHT	WEIGHT	CELL PHONE	
	EMAIL realbrotherdank@gmail.com	RESIDENCE ADDRESS ***				HOME PHONE ***				
	EMPLOYER NAME	BUSINESS ADDRESS ***				WORK PHONE				

NARRATIVE
<p>HATE CRIMES ON TRIMET LIKE THOSE THAT WERE LATER ASSOCIATED WITH A MURDER ON THE BUS WERE COMMITTED AGAINST ME ON THE BUS BY MY LINE 6 BUS DRIVER AND A GANG WITH MILITARY GRADE INTELLIGENCE AND TACTICS. BUS DRIVER ALLOWED A RIDER TO ASSAULT ME WITH MILITARY GRADE INTELLIGENCE AND TACTICS, "FUCK YOU NIGGER," FROM THE WHITE SUPREMACY GANG LEADER. BUS DRIVER APPROVED, LET HIM OFF AT GERTZ ROAD TRAILER PARK, AND THEN LET HIM BACK ON THE BUS SO THAT HE COULD FURTHER INSTRUCT HIS GANG TO "FOLLOW THAT MAN!" WHICH THEY DID FOLLOW ME ACROSS STATE LINES GANGSTALKING ME ON MY WAY TO WORK AND BACK. WTG, TRIMET. FBI SAID SOUNDED LIKE "NOT A CRIME" TO THEM WHEN I REPORTED INCIDENT IN 2014.</p> <p>SO, WHITE SUPREMACY GANG ON TRIMET LINE 6, TELL PEOPLE FUCK YOU NIGGER AND STAB PEOPLE ON THE BUS, THE BUS DRIVER AND THE MILITARY ARE INVOLVED. I WAS THE ONLY NON-GANG PERSON ON THE BUS, IT WAS APPARANTLY THE WHITE GANGS DAY TO RULE THE BUS BECAUSE THERE WERE NO BLACK PEOPLE ON THE BUS EXCEPT FOR THIS NIGGER. NORTH PORTLAND IS ATE UP ON VOICE TO SKULL NEUROWEAPONS. THATS WHY EVERYBODY'S GANGSTALKING EACH OTHER. YALL NEED TO HAVE MILITARY INTELLIGENCE TO CALL ME AND DEBRRIEF ME. (TINYURL.COM/HOMETOWNTEAROR CLICK THE EM EFFECTS ON HUMAN BODY FOLDER, DESCRIBES NEUROWEAPONS EXPOSURE TO THE GENERAL POP.)</p> <p>I ALSO GOT GANGSTALKED BY VARIOUS OTHER YOUNG ADULTS ON TRIMET 6 AND YELLOW AND OTHER LINES AND LINE 8 I BELIEVE THE ONE THAT WENT DOWN N. MISSISSIPPI IS AN OPEN AIR DRUG MARKET AND THE BUS DRIVER AND THE ENTIRE GANG IS WORKING TOGETHER ON THAT TOO.</p> <p>THANK YOU FOR APPREHENDING THE INSIDER CYBERNETIC THREAT TO OUR REPUBLIC. AFTER 9/11, ITS SEE SOMETHING SAY SOMETHING, WORKING TOGETHER, HEARTS AND MINDS, FREEDOM FOREVER SECURED, NO MORE 9/11, ULTIMATE VICTORY. THATS WHY PDX SACRIFICED THEIR FREEDOMS WITH THIS PSYCHIC WEAPON. WE GOTTA STOP GANGSTALKING OURSELVES WITH IT AND INSTEAD USE IT TO SAVE THE CHILDREN.</p>

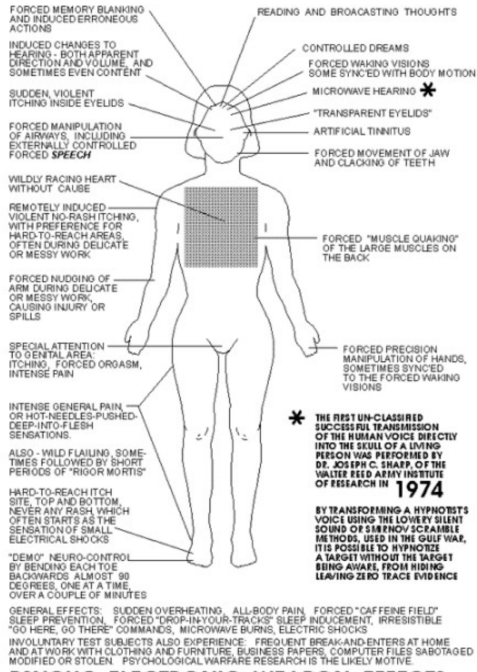

PSYCHO-ELECTRONIC WEAPON EFFECTS

www.raven1.net

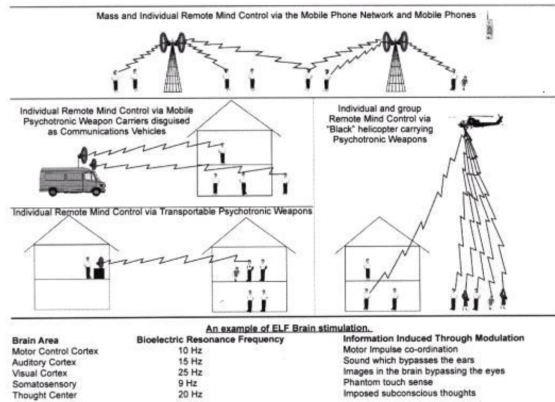

Remote Mind Control / Remote Brain Mapping



ST. LANDRY

UNAPPROVED CITIZEN INCIDENT REPORT - NOT FOR OFFICAL USE

SHERIFF BOBBY J. GUIDROZ

Address: 1592 E PRUDHOMME STREET OPELOUSAS LA 70570

Report Number	Created Date	Reviewed	Agency ORI
OL-21-000121	9/19/2021 8:27:00 AM	NO	LA0490000

Reporting Person				
Name	DOB	Age	Gender	Race
LUCITO DAVID E	06/10/1984	37	M	
ID Number	Email	Phone		
	REALBROTHERDANK@GMAIL.COM	337-326-9914		
Address	CITY	State	Zip Code	
104 TILLOU ANDRUS DRIVE	OPELOUSAS	LA	70570	
Best Time to Contact	Secondary Phone			

Offense Details			
Title	Began	Ended	
OFF3 OTHER	9/19/2016 8:27:00 AM	9/19/2021 12:00:00 AM	
Address	City	State	Zip Code
104 TILLOU ANDRUS DRIVE	OPELOUSAS	LA	70570

Suspect Details							
Name	DOB	Age	Gender	Race	Height	Hair Color	
UNKNOWN "REBECCA"		37	F	W	0'00"	BRO	
Hair Style	Eye Color	School				Grade	
	UNK	ARMY/CIA?					
Features			Clothing				
CYBERWEAPONS OPERATOR							

Vehicle Details				
Make	Model	Year	Color	Value
MERCEDES-BENZ	BLACK SUV'S, DRONES			
License Number	State	Year	VIN	



ST. LANDRY

UNAPPROVED CITIZEN INCIDENT REPORT - NOT FOR OFFICAL USE

SHERIFF BOBBY J. GUIDROZ

Address: 1592 E PRUDHOMME STREET OPELOUSAS
LA 70570

Statement

REPORTING ONGOING "ANOMALOUS HEALTH INCIDENTS" INVOLVING "CYBERTORTURE" AND "HAVANA SYNDROME" IN THE PARISH AND ACROSS OUR STATE AND NATION. MY TARGETING FEATURES NAUSEA FROM DIRECT NEUROLOGICAL MUNITIONS EXPOSURE PAIRED WITH WITH STRANGE SENSORY PHENOMENA SUCH AS HEARING VOICES OR BIRDS OR CRICKETS CHIRPING. THESE SYMPTOMS ALIGN WITH THE SEPT. 15 MEMO FROM OUR DEFENSE SECRETARY URGING MILITARY AND CONTRACTOR VICTIMS TO REPORT THE THREAT TO ALL APPROPRIATE CHANNELS. AS A CIVILIAN I AM DOING JUST THAT. STANDING BY FOR MILITARY INTERVENTION WITH JOHN AND JANE DOES IN DIRE DISTRESS ACROSS LOUISIANA AND AMERICA. TO BE CLEAR: ANOMALOUS HEALTH INCIDENTS ARE OCCURING IN THE NON-MILITARY GENERAL POPULATION.

PLEASE DO NOT SEND A CONVENTIONAL RESPONSE TO MY HOME. I CAN ONLY ACCEPT A MILITARY INTERVENTION EQUAL TO THIS EMERGENCY. THE LAST TIME I WENT TO OGH SOUTH FOR NEUROWEAPONS EXPOSURE I WAS SIMPLY CONTINUALLY CYBERTORTURED IN THE HOSPITAL. SEE 911 CALL IN MARCH FROM OGH SOUTH. THE GUARD MUST RUN A FULL-FIELD HUMINT AND SIGINT AUDIT, WILL REVEAL TORTURE OF AMERICANS BY OUR OWN FORCES. TARGETS NEED THEIR INJURIES EVALUATED STUDIED AND TREATED BY MILITARY EXPERTS. THIS IS A NATIONAL SECURITY EMERGENCY AND A NATIONAL MEDICAL EMERGENCY. SOS.

Files

	<p>Name: Screenshot_20210919-081017.png</p> <p>Comments: SecDef 9/15 memo on Anomalous Health Incidents</p>
	<p>Name: 2RNM.jpg</p> <p>Comments: WA State Fusion Center disclosure describing cybertorture of Americans at Portland, OR waterfront. Confirming: I personally attended this 2017 event and it was a cyberweapons disaster.</p>
	<p>Name: 9RNM.jpg</p> <p>Comments: WA State Fusion Center disclosure describing cybertorture of Americans at Portland, OR waterfront. Confirming: I personally attended this 2017 event and it was a cyberweapons disaster.</p>
	<p>Name: EM effects on human body.gif</p> <p>Comments: WA State Fusion Center disclosure describing cybertorture of Americans at Portland, OR waterfront. Confirming: I personally attended this 2017 event and it was a cyberweapons disaster.</p>
	<p>Name: WW (1).pdf</p> <p>Comments: UN document detailing the 21st Century threat, Retired Air Force Veteran describes the threat to American lives</p>



ST. LANDRY

UNAPPROVED CITIZEN INCIDENT REPORT - NOT FOR OFFICAL USE

SHERIFF BOBBY J. GUIDROZ

Address: 1592 E PRUDHOMME STREET OPELOUSAS
LA 70570

<input type="checkbox"/>	Name: GundersonAffidavit (1).pdf Comments: The late Ted Gunderson, FBI, describes human intelligence operations known as gangstalking, claims programs are tied to human trafficking, etc.
<input type="checkbox"/>	Name: FFTI.pdf Comments: UN published Freedom From Targeted Individuals description of the threat to American lives
<input type="checkbox"/>	Name: Thomas_CDR V5N2 Summer 2020.pdf Comments: American assessments of the relevant Russian capabilities.
<input type="checkbox"/>	Name: ElectromagneticTorture.pdf Comments: UN published document describing the threat.
<input type="checkbox"/>	Name: Energyweapons.pdf Comments: UN published document describing the threat.
<input type="checkbox"/>	Name: G2007073 (1).pdf Comments: UN Special Rapporteur on Torture Nils Melzer outlines the problem of "cybertorture."
<input type="checkbox"/>	Name: Militarygrade.pdf Comments: UN published document describing the threat.
<input type="checkbox"/>	Name: Mindcontroltechnology.pdf Comments: UN published document describing the threat.
<input type="checkbox"/>	Name: Harrassmenttechniques (2).pdf Comments: UN published document describing the threat.



ST. LANDRY

UNAPPROVED CITIZEN INCIDENT REPORT - NOT FOR OFFICAL USE

SHERIFF BOBBY J. GUIDROZ

Address: 1592 E PRUDHOMME STREET OPELOUSAS
LA 70570

<input type="checkbox"/>	Name: SOS.pdf Comments: Example of thousands of emergency communications describing the threat across all channels.
<input type="checkbox"/>	Name: Advforhumankind4.pdf Comments:
<input type="checkbox"/>	Name: Advforhumankind3.pdf Comments:
<input type="checkbox"/>	Name: Advforhumankind1 (2).pdf Comments:
<input type="checkbox"/>	Name: Advforhumankind2.pdf Comments:
<input type="checkbox"/>	Name: portlandtrimetpolicereport.pdf Comments: A description of the situation in Portland Oregon metro where uniformed police responding to the emergency tell you, "Its normal to hear voices."

...---... EMERGENCY SOS ...---...

EMERGENCY COMMUNICATIONS FOR FBI DIRECTOR CHRISTOPHER WRAY.

SUBJECT: SOS. WAR CRIMES AGAINST TARGETED INDIVIDUALS.

SOS. CIVILIANS IN DIRE DISTRESS. OFFICIAL CHANNELS COMPROMISED. NEUROWEAPONS TARGETING NONCOMBATANT AMERICAN VETERANS WOMEN AND CHILDREN. US MILITARY FRIENDLY FIRE CONFIRMED BY POLICE.

OPERATOR SYNDROME AMONG THE CASUALTIES. FIELD HOSPITALS AND MEDICAL PROTOCOLS NEEDED ASAP. WHOLE METROS EXPOSED TO WEAPONIZED CYBER CAPABILITIES INJURING ALL PARTIES.

SITUATION: MORTALLY SENSITIVE, EXTREMELY DELICATE, SUPREMELY URGENT.

...---...

I DO NOT KNOW YOUR LEVEL OF REAL CLEARANCE ON THESE MATTERS, BUT I DO KNOW THIS 21ST CENTURY OPERATIONAL STANDARD: SECRETS SINK SHIPS! LIES MAKE US WEAK!

WITH THESE SAME TECHNOLOGIES WE COULD SAVE THE CHILDREN OVERNIGHT AND ENJOY A BRAND NEW DAY CALLED AMERICA AROUND THE WORLD. I MEAN MISSION ACCOMPLISHED FOR ULTIMATE VICTORY: FREEDOM SECURED FOREVER.

INSTEAD, I AM ON-DUTY REPORTING THE TORTURE TO DEATH OF AMERICAN CITIZENS IN THEIR OWN HOMES! SOS!

I'VE LOCATED SOME CLASSIFIED RECORDS AT NSA AND DHS I&A THAT I SUSPECT RELATE TO MY OWN TORTURE. DOMESTIC TERRORISM IS NOT A NATIONAL SECURITY STRATEGY!

THIS IS A REAL EMERGENCY THREAT TO THE REPUBLIC! RED ALERT. DOMESTIC TERRORISM. SOS! MILITARY INTERVENTION REQUIRED. THAT IS A LAWFUL WARTIME ORDER! SOS!

PLEASE DISPATCH A GUARD UNIT IMMEDIATELY TO DEBRIEF ME FOR A DEPLOYMENT OF CORRECTIVE FORCES! I ASSURE YOU, THERE IS NO AMERICA UNTIL I PERSONALLY WITNESS AN OFFICIAL RESPONSE FROM THE COUNTRY I WAS BORN TO SERVE.

UNTIL I SEE THIS RESPONSE IT IS CERTAIN THAT BOTH OF MY GRANDFATHERS WON WWII FOR NOTHING WHATSOEVER, FOR AS LONG AS AMERICAN FORCES CONTINUE TO MINDLESSLY DESTROY THEIR DECENT FELLOW AMERICANS.

THIS IS NOT ACCEPTABLE! SOS! ...---...

DAVID LUCITO 337 326 9914
104 TILLOU ANDRUS DRIVE
OPELOUSAS, LA 70570

...---... EMERGENCY SOS ...---...

Dear Nils,

I am writing to you as a Life Coach who is generally very well educated in human behaviour, psychology and in promoting effective change on the base of this. I am also a victim of remote neuro-weapon abuse. Also called electromagnetic weapons, microwave weapons, mind control technology or 'cyber torture'. This therefore makes me a credible witness therefore to what I am about to say...

In the case of mind control technology the core issue is that it is even being used in the first place as it is against the UN and EU charters of human rights. No one should have the right of 'freedom of mind' itself taken away from them. It is quite frankly an atrocity and is **pure psychological torture**.

Relating to the aim of your report, the predominant psychosocial dynamics which in this instance are completely paralysing institutional checks are the following...

- 1) Fear
- 2) Apathy
- 3) Misunderstanding
- 4) Societal brainwashing
- 5) Government brainwashing
- 6) Ignorance
- 7) Suppression
- 8) Beliefs of limitation both within individuals and what they believe to be their 'model' of the world.
- 9) Time – although some may argue that this is not a psychosocial dynamic in itself It is seen by many in psychological and spiritual circles of expertise as a part of the human psyche just as much as the ego itself. Time and the 'rush' and 'pressure' of modern day society has become one of the biggest barriers to taking an interest in our human rights.
- 10) Oppression through psychological manipulation, threatening behaviour, blackmail or force.
- 11) Untruthful or biased mainstream media.

These factors consist both of what we are doing to ourselves and what is being done to us. Really they are two sides of the same coin in the effect of paralysing institutional checks.

All of the above factors are generally true on the levels of the average citizen, the government oppressors, the innocent government bystander and most shockingly even those that are supposed to help and therein lies the problem.

This has been the case very much in the case of victims of mind control technology aiming to expose the truth. The evidence has been there all along with credible whistle blower testimonies, scientific patents, victim testimonies, measurement off attacks, leaked and declassified government documents pertaining to mind control and much more but **it is a subject that takes a bit of investment to learn** the distinctions that gives one the confidence to join the fight against this severe human rights abuse. In addition to fear and time the other biggest barrier is the barrier of belief in what is possible (i.e. no 8). For some people it is just too big a leap of belief to take (and too fearful) to even desire to start to go down the path of self-education. Their beliefs are built in a very permanent and fixed way with a lot of ego investment meaning that it is very hard for them to 'stretch' their ideas of what is possible (even if it is true!).

To quote your own words...

Relevant phenomena include patterns such as 'system justification', 'wilful ignorance', 'bystander apathy', 'diffusion of responsibility', 'obedience', 'utilitarian moral disengagement' and 'group based moral disengagement'

These are all factors that strongly play into the minds of the people who give the commands for neuro weapon torture as well as the next in line who actually operate the weapons. The 'excuse' is that it is done in the name of national security whereas in reality it is just torture with the aims of control and devastation (and I will confidently say slow murder). It breaks the majority of UN and EU charters. People as we know have a hard time due to fear in standing up to authority and we still live in a society where whistle blowers are not protected.

Another key psychological 'driver' is that our need to stay consistent with what we see as our identity (or who we are) and is the strongest psychologically driving force in the human psyche. As an example, If we see ourselves as someone who always see's the best in people for example we may have already made the decision to reject anything that shows the dark side of what human beings are capable of. On the opposing side this can be used as a manipulating force to keep people in the dark by manipulating them based upon the idea of their 'identity' or even changing the nature of that identity itself.

The need for 'power' also as history has shown has always been a driving force behind human behaviour for 'self' and 'other' recognition.

These above principles of course (1-9) could be applied to any aspect of psychological torture or reasons why institutions/ government institutions undermine, circumvent or paralyse their checks to stop these abuses.

On an everyday level it is true generally that something we cannot physically see with our own eyes therefore deceives us into thinking that somehow it must be not true. In simple terms this is what we are dealing with microwave weapon assaults. This again is used to the perpetrators advantage for maximum denial as it is challenging to prove and the victim sometimes may wrongly come off as mentally unstable (which of course is their goal to discredit them).

I also feel the need to talk about the mind control technology or 'cyber torture' as you have described it. The psycho-social dynamics that stop institutional checks are the very symptoms of the mind control within the targeted individuals themselves...

<https://tinyurl.com/y9ov4fev> (please look fully at this symptom list of electronic harassment and the links at the bottom of this link– they are all very informative!)

For a more in depth look at the symptoms of **electronic harassment** and **'gang stalking'** please take a look at the following affidavit template which labels all of the possible symptoms of these 2 aspects of psychological torture that Targeted Individuals typically face (the template was based upon all symptoms the author had heard of in the field or experienced herself).

<https://stop007.org/wp-content/uploads/2018/11/jit-survey-final.pdf> (I am asking you again politely again to please also take the time to look fully at this list – it is very informative and will give you a better idea of the dynamics that make up this cyber tech crime including all the psychosocial dynamics you wish to know)

I also recommend contacting Kathrine Horton as she would be an excellent contact and is currently undergoing a court case against the UK intelligence agencies re all this.

In regards to why people would have a hard time understanding mind control technology is because people generally will only believe more readily those parts of life that fit in with their pre-existing belief. That is how such distorted perceptions of reality are allowed to continue which relates strongly to points 1 -9 above . Like always we ‘backwards’ rationalize our actions that were performed to fit in line with our belief about reality. Again this ‘filtering’ through our beliefs has been used as a societal brainwashing through mass media and government propaganda for many decades. Again, two side of the same coin are relevant to psychosocial dynamics– personal and societal.

On a practical note how could governments start to recognize and stop ill treatments of psychological torture (and its components) and start to bring about policy to stop these abuses??

Well first and foremost it is a matter of course of education and awareness. If government organizations are firstly educated about the technical knowledge of the wrong doings of their governments and intelligence agencies then that will go a long way. But if people in the top levels of government are aware of the psychosocial dynamics they can pass laws that prevent **psychological abuses with intent**. They can also then take measures to not only stop these aspects in themselves in the initial phases of learning about this subject but also be aware when teaching others of the natural barriers to learning about challenging subjects of this kind where psychological barriers can become obstacles. With new laws they can also be aware of how oppressors are using these psychosocial aspects against victims to get away with it as they understand the psychology of it. They can then enforce these policies with independent oversight to counteract these psychosocial abuses. Eventually, teaching history of government abuses with full transparency is the best way to really learn from the past and move forward. New legislation is always best brought in after any atrocity fully comes to light to the vast majority of the population. This is the best way to stop psychological torture and all its associated forms of psychological manipulation (transparency). Accurate history gives people a basis with which to learn and accept new information perhaps about mind control weapon abuses and how they have been used wrongly against society.

Looking at the positive....

That said, we are now at the stage where we can start the process into many positive changes in the area of neuro-weapons abuses to bring about the end of these abuses once and for all. We can as a society start the process of disarmament just like it is the UN’s goal of disarmament for all other weapons of mass destruction and I would classify Mind control weapons (or directed energy weapons (DEWS)) as just that. As a side note - it is my understanding that directed energy weapons (in which microwave weapons are a part) have the power to destroy buildings, assassinate individuals and even take out large parts of cities in electromagnetic pulse attacks (EMP) therefore it is important to be aware of the capabilities of various types of DEW in general.

As we look around us people are now more willing to change and work on all aspects of themselves and there are a lot more open minded and aware people than they were 30 years ago. We just need to look at the boom in the personal development and truth movement industries to see this. People generally are now more willing in my opinion to look into the ‘uncomfortable’ aspects of society and the recent peaceful and genuine protests show that people are fighting for their human rights more than ever.

Here are some goals that I put together that stand as a common set of collective goals that I believe are needed as we start the process of passing laws to protect innocent civilians from mind control assaults...

<https://tinyurl.com/y76bey4l>

In summarise the above, acknowledgement by governments needs to occur and they need to be held accountable. **Specific** laws needs to be passed to protect innocent civilians from microwave attacks. Frequency police need to be established to track and trace perpetrators. **We must move collectively towards full disarmament as a society of mind control weapons.** Lastly, in the interim at the very least proper watch listing procedures need to be put in place. These need to be established so that at least it is only true terrorists who are put on these lists who are a real and genuine danger to national security. Innocent civilians, those who just have an opinion, those who speak out about corruption and those who have not broken any laws should NOT be watch listed. Currently this is not the case hence the case of 'Targeted Individuals'. Regular assessment of watchlist status needs to be introduced with regular independent oversight and surprise visits to locations. Currently there is not enough review. How do I know this? Because I have only ever come across two cases where microwave weapons abuses stopped for an individual and neither of them was a 'regular' citizen (both were ex intelligence agency workers). Perhaps even a shutting down of venues/ institutions that continue to reoffend is needed.

PLEASE NOTE: IT IS THE US AIRFORCE AT SHRIEVER AIRFORCE BASE THAT COULD BE RESPONSIBLE FOR A LOT OF THESE ATTACKS ON THE WORLDS CITIZENS ACCORING TO NASA WHISTLE BLOWER RICHARD LIGHTHOUSE (see link below). Essentially US citizens are being placed on their national watchlists and international citizens (and some US citizens) are being placed on the international 'terrorist' watchlist called Terrorist identities datasmart environment or more simply called the international TIDE watchlist.

<https://tinyurl.com/y473wpga>

TIDE watchlist on Wikipedia...

<https://tinyurl.com/ybonfxvo>

Here are 500 testimonies of microwave weapons and 'gang stalking' victims in the link below. Electronic harassment and 'gang' stalking (as the latter name for modern COINTEL pro operations is commonly known) are the two crimes most often used by governments often together to completely take down an individuals life and demobilize them usually to the point of despair and quite commonly suicidal tendencies. These testimonies will give you a much better idea in itself of the psychosocial dynamics that are limitations to institutional paralysis and corruption (not just from the point of the victim but also from the point of the oppressor who uses the mind control technology and all the psychological operations that come with that (which includes most of the psychological aspects from 1 -9 above). **Part of the problem is due to 'Targeted individuals' having to battle the effects of the mind control daily and so not having the strength or ability to speak out in the midst of the strong counter programming effects of the technology. This counter programming is the real issue alongside the more 'normal' psychosocial barriers discussed earlier for the victims themselves personally alongside the psychosocial barriers being imposed on them through the mind control technology.**

Note: intelligence agencies are also well known for disinformation, slander, stalking and harassment campaigns – all part of psychosocial torture. They need to be recognised in order to stop this.

<https://tinyurl.com/y8toh396> (please note you will have to download the file in order to see it)

In summary, the normal everyday psychological aspects like fear, time, belief, apathy and government/ society programming in combination with the sheer force of the mind control itself on the victims is why this has been the most likely one of the most challenging cases of suppression of individuals the world has ever known. We must put an end to these abuses now to make sure that our children always retain full use of their own mind and faculties and that these weapons are not potentially used for the psychological enslavement of mankind.

Many thanks for your time as always. I and all the victims of mind control technology really genuinely appreciate your help in starting to bring about an end to the abuses.

In gratitude and sincere thanks,

████████████████████

Harassment techniques include:

1. Surveillance (being followed, electronic surveillance, computer and phone hacking, monitoring all online activities, and bugging of home)
2. Profiles are built to identify any and all weaknesses and insecurities to be used later. Information often obtained through sexual partners or trusted people in their lives.
3. Conditioning where victims are sensitised to certain stimuli such as everywhere you go someone will cough as they walk past you. The goal is to make you self police and then think anyone who coughs is involved in the harassment. People report of conditioning to include hand gestures, an overt use of colour in peoples clothing (like everyone you see wearing red) or cars a certain colour or with headlights on (also known as brighting).
4. Anchoring where someone will provide false rationales for the harassment. Often many possible rationales are planted to keep the victim confused and the focus of the harassment cycles from one possible reason to another round and around so as to keep the victim guessing in a self perpetuating guessing game where every scenario you are to blame and causes self doubt, fear, intimidation, and ultimately a cycle of destructive thoughts
5. Mobbing (or true gangstalking) where everywhere you go you will see an overt display of people following you and often use words you have been conditioned to or your name to draw your attention
6. Street theatre where a group will "perform" an overt activity like a fake confrontation or scenarios designed to test your reactions. Often takes the form of a couple who position themselves near you and then have a conversation using many of your conditioned words or pertaining to your particular situation and sensitivities.
7. The use of directional speakers which have the ability to direct sound to a single individual in a crowded room. This particular item is ultimately the most used and is often referred to as V2K or Voice to Skull and is used extensively in the psychological breakdown of the victim. The use initially is to cause the victim to doubt their sanity and drive them into the mental health system, and later to just torment and never give the victim a moment of privacy or peace. If they do enter the mental health system, then harassment escalates dramatically as the victim has now been "discredited" and can be labeled as someone with a mental problem if they do speak out about the harassment.
8. The use of electronics to effect your eyesight and balance which was originally developed for the military and police crowd control called "dazzling" and even the ability to make you vomit.
9. Sound campaigns which is a community harassment technique where abnormal levels of sound are directed at the victim and their home. This includes cars deliberately breaking or accelerating when they pass, people talking excessively loudly at all hours of the night, amplification of sound using directional speakers so that external sounds that previously couldnt be heard now can, garbage trucks and other heavy vehicles, and countless other deliberate tactics
10. Sleep deprivation - this is perhaps one of the most insidious tactics used where victims are woken multiple times a night and can be kept awake for days at a time. The effects are dramatic and completely debilitating effecting concentration, mood, irritability, appearance, and significantly impacts all areas of their life - job performance, relationships, and significantly aids in discrediting the victim as

they appear unorganised, disheveled, and sleeping patterns alter so they may sleep during the day (where noise campaigns are more effective) and be awake at night (where they can be painted as the one making noise and being a disruptive member of the community).

11. Baiting or entrapment where victims are harassed to the point that they lash out and commit a crime such as assault, break and enter or vandalism, as they try and locate the source of the harassment. Harassers will actively try to provoke verbal and physical confrontations especially after a period of sleep deprivation. Or they are prompted into an activity which can then be used as leverage such as affairs, sexuality, drug use, or other criminal activity.

12. Gaslighting which is a form of psychological abuse where someone will actively try undermine victims and to make them doubt themselves so that they lose all self confidence and self esteem and are therefor easier to manipulate and push toward the mental health pathway. It can be as simple as being told something which they then deny, then telling them how silly they are for thinking they said it, and turn the lie around into an attack on the person. It can be incredibly effective coming from a trusted person and before the victim understands what is happening to them.

13. Blackbag jobs is a term when a harasser breaks into a victims property and places something or deliberately moves something. The purpose is to cause self doubt, and fear that their property is being accessed which harassers try to then sell as paranoia.

14. Propaganda and disinformation is also the other key element to suppress knowledge of this practice as its effectiveness initially requires the victim to be unaware of the existence of gangstalking, gaslighting, or the electronic technologies such as directional speakers so huge amounts of time are devoted online to creating disinformation sites which attempt to discredit victims by pushing the mental health agenda. They achieve this by posing as victims and actively trying to sound crazy so that all victims are treated as such. Also by creating websites claiming to help victims and being a resource for victims to come together and then harassing them to the extent that they lose hope and no longer reach out for help causing further isolation.

15. Further to the above, gangstalkers rely on disbelief and discrediting and as such much of the harassment is designed (at least initially) to mimic mental health issues. They also rely on their abuse being so extreme, so pervasive, so fundamentally immoral, as to be disbelieved and victims subsequently resort to photographing, videotaping, and sound recording their everyday encounters to disprove the countless unfounded claims made against them - especially in relation to gaslighting, which gangstalkers try to turn around and paint the victims as paranoid or irrational. Victims are made to feel helpless as every attempt to defend themselves is used against them and when they seek help they are met with disbelief or open hostility.

traceless mental harassment. Using this, the harassers beam-in abusive voices directly into skulls of the Targeted Individuals by-passing their ears. Harassers interrupt and censor the victims' normal thinking when travelling anywhere in society by beaming in abusive voices into the victim's head constantly - hence spoiling work-tasks completion. **(Victims also get wrongly labeled as mentally-ill when reporting about this, not many are aware about novel neuro/electromagnetic/bio weapons and its capabilities)**

V2K is also used for Deception (causing confusion by beaming voices inside skull in-between talks when TI is talking to other people) and Impersonation of voices of close persons (whenever close persons are talking to TIs, these perpetrators intertwine their own voices along with the close persons voices by a technology named '**EEG Heterodyning**')

TOTAL LOSS OF PRIVACY: Surveillance is usually carried out first unannounced secretly for years - without the targets ever being able to detect that their innermost details had been collected and stored - and that their own eyes themselves are made to act as cameras giving the latest details about themselves and the places and persons they visit. These devices are suspected to be authorized to access government satellites and are linked to supercomputers for data analysis and harvesting purposes. Victims have no privacy anywhere on the planet (bathrooms and bedrooms included).

HARMFUL EFFECTS: The targeted people's physical health, hygiene, peace of mind, career and social credibility, family, friends and other relationships - all these get seriously downgraded and systematically made to fade out via the above torture program. A primary goal in these 'slow-kill', 'no-touch'/'soft-kill' programs is to remove TIs from the job workforce - so that they are in range at home for longer times to facilitate more testing, refining of weapons and for training more operators and neural programmers. **The combined impact of all these together - physical wounds, 24x7 psychotronic warfare, career systemically made to vanish IS DEVASTATING to TIs, to say the least.**

WORLDWIDE ISSUE: Dr. John Hall, M.D. (Doctor and Author, USA) who has analyzed the above phenomenon personally - calls this as '**Satellite Terrorism**' and the **greatest threat to humanity as a whole in the near future.**

Finally, there are hundreds of victims in India currently and many hundreds across the world as well [REDACTED] - as long as the public are unaware of the above secret surveillance on mass scale by these secretive operators, more innocent civilians could be targeted in future as well. All these NO-TOUCH torture with Directed energy weapons and Voice-To-Skull are remotely-controlled. Thus, this full protocol (Organized Stalking & Electronic Harassment - 'OSEH' in short) leaves the least physical evidence of any wrong-doings and has become strongly prevalent inside many nations. This leaves us with a very rudiment question of a dignified human life, What is more worse in this world than your body, brain and mind getting hacked and harassed covertly and illegally?

We humbly request UNHRC to take due cognizance of the above issue and include all non-consensual experimentation /covert torture programs of these remote monitoring/influencing systems and weaponized technologies as severely punishable human rights violations and a life threatening Cyber-Crime, which needs urgent investigation, legislation and MOST IMPORTANTLY due justice given for Targeted Individuals who are severely affected by this NO-TOUCH torture perpetrated by covert criminals. Also request world countries through UNHRC, to safeguard our dignity to human life with immediately stopping this crime, provide monetary compensation for the loss of productive life and provide MIL-grade shielding which will protect us from getting attacked by such energy weapons!

PLEASE REFER the below sources for Proof of existence of such weapons:

When neuroscience leads to neuroweapons

https://thebulletin.org/2016/10/when-neuroscience-leads-to-neuroweapons/?fbclid=IwAR3IB00SHKaOM56SsQJ2xdyiqXN7UD0cZPf_xJ7vVbdBLsokDj0Dt-K0sLo

US army developing synthetic telepathy

<https://timesofindia.indiatimes.com/home/science/US-army-developing-synthetic-telepathy/articleshow/3596708.cms?fbclid=IwAR2kun6TsipA73-7b6bASJpajH1FBW9pheQKdfXzHZ6ptvh7mzXN6eNLAYl&from=mdr>

Spooky mind reading technology

https://www.deccanchronicle.com/nation/current-affairs/200519/spooky-mind-reading-technology.html?fbclid=IwAR01Gt-BmNZ1C7iucj81jyRh1DGMw9qmy6RYdOppYmQpBv8kvU7FZY_-D7Q

From Psyops to Neurowar: What Are the Dangers?

http://web.isanet.org/Web/Conferences/ISSS%20Austin%202014/Archive/b137347c-6281-466d-b9e7-ef7e0e5d363c.pdf?fbclid=IwAR3_XOP5zWgIglNmbOE0J85LBqf0NDIjcA5Gw5ImqlraR68yDQy497c3BVn4

Weapons of perception: neuroscience and mind-controlled weapons

<https://www.army-technology.com/features/featureweapons-of-perception-neuroscience-mind-controlled-weapons-and-the-military/>

Note: Kindly request confidentiality of my report

-----End of Report-----

Electromagnetic harassment with torturous patterns (electromagnetic torture, cybernetic torture or cybertorture): “the crime that people complain most about on the internet/social media”

Relevance to neuroweapons as well as “Health Attacks” or “Health Incidents” of U.S. and Canada diplomats

Dynamics conducive to corruption and torture: Neuroweapons having top secret status similarly to “weapons of mass destruction” are expected to be subject to limited or non-existent parliamentary / congressional supervision

Electromagnetic harassment with torturous patterns has been referred to as the “crime that people complain most about on the internet/social media”. It is argued that the “health incidents” or “health attacks”, according to the terms of the U.S. State Department, which affected the U.S. Embassy diplomats in Cuba and China (and similarly the Canada Embassy diplomats in Cuba) are linked to this phenomenon [*]. A precedent is found in the microwave irradiation of the U.S. Embassy in Moscow (1953–1976) [*]. Many thousands of people internationally complain of being electromagnetically harassed with torturous patterns (electromagnetic torture, cybernetic torture or cybertorture).

Health attacks are currently the object of an interagency investigation of the U.S. government coordinated by the “Health Incident Task Force” created by the U.S. Department of State [*]. Three scientific publications present evidence of brain damage of the diplomats [*][*][*]. A U.S. Congressional hearing reiterated the diagnosis of brain injury as a result of the attacks [*]. The U.S. Government Accountability Office assessed the response of the State Department, published a report [*] and presented its findings to Congress [*]. Given the neurological nature of the attack, the technological means that would have been used are defined as neuroweapons. A group of experts, including the first physician who examined the U.S. diplomats, gave presentations on the health attacks at a neuroweapon event held by SOFWERX and the U.S. Special Operation Command [*]. A briefing of the Pentagon Chiefs of Staff was conducted by the same group of experts [*].

U.S. victims of electromagnetic harassment have provided comment to the Presidential Commission for the Study of Bioethical Issues (created by President Obama) in March and May 2011 [*][*]. In Europe, the Ministry of Defense of Poland conducted a geographical analysis of complaints of Polish victims for electromagnetic attacks in 2016 [*]. Following correspondence with the Ministry [*], Polish victims have been heard by the Inspectorate of Innovative Defense Technologies of the Ministry of Defense.

Among different protests against electromagnetic harassment/torture, two international rallies have been held on the 29th August in 2019 and 2018 [*].

Victims of electromagnetic harassment, often called “Targeted Individuals” or “TIs” report:

1. Torturous routines such as head and body electromagnetic stimulation e.g. intense sudden contractions of (surface) muscle fibers equivalent to painful stimulus of being hit, different stimulation patterns generating miscellaneous effects e.g. pain, tingling, pins-and-needle effect and also intense heating, burning or itching sensations.

2. Artificial tinnitus, hearing voices and mental manipulation i.e. mental content presentation/insertion and extraction (personal thought content being repeated to them in an interval of a few seconds).

3. Manipulation via brain-to-brain interface: A remote human operator exerts a dominant cognitive influence determining certain functions (e.g. a motor function such as moving a limb).

Targeted Individuals are being tortured silently while certain phenomena such as "hearing the global Hum" which affects 4% of the world population [*] may be indicative of the fact that the effects are being experienced by a much larger population than that of targeted individuals.

Given the extremely advanced nature of the symptoms reported, e.g. mental manipulation, the associated neuroweapons, also termed "weapons of mass disruption" should be considered equivalent, in terms of national security, to "weapons of mass destruction". It is expected that these would be top secret, would be handled only by few people in the highest military ranks, and would probably be subject to limited or non-existent parliamentary/congressional supervision (cf. generic reporting citing indispensable covert national security operations). This setting would cancel institutional controls, thereby creating environments conducive to corruption.

It is important that society addresses electromagnetic harassment with torturous patterns or electromagnetic torture (cybernetic torture or cybertorture). It constitutes a significant human rights issue with severe risks on the health, well-being and the life of individuals. It is also important to comprehend the implications, as the complaints of the targeted individuals referring to both torture as well as mental manipulation may be indicative of a future where mental interference may be performed in large scale with imperceptible nuances and nudging of thinking towards certain directions e.g. for political or economic interference. It is urgent to address this phenomenon.

Inputs for psychosocial dynamics conducive to torture and ill-treatment report

sr-torture@ohchr.org

Thousands of innocent civilians are tortured worldwide by means of directed energy weapons. The torture can be psychological, physical, or both. The advances of military technologies, particularly neurotechnology and artificial intelligence, mean that it is now feasible to target the population even remotely, by means of stealth technology.

Such weapons are not only in the hands of criminal organisations, but also in the hands of the States and states' contractors, who test them and deploy them on the population without leaving any trace. Countless people worldwide report being subjected to severe trauma and suffering through cybertorture. Yet, lack of proof means that all personal accounts fall in the realm of speculation and expose targets to a double victimisation, as most are considered delusional, or part of a conspiracy theory. Fear of stigmatisation and lack of information leads to silence, most targeted individuals suffer in silence.

These weapons are the almost exclusive monopoly of the secret services, who have been granted *carte blanche* in the name of national security, and since ordinary police forces do not have the information or access to classified military technology they have no means to protect the public. Citizens become playthings, involuntary test subjects, and since these programs are allegedly life long for fear of leaks, they are literally held *captive*, even though they may be geographically remote in their dwellings. Once "brain-tagged" through their own individual brain resonance signature they are followed, harassed, subjected to behavioural modification programs anywhere on earth.

Experimentation on citizens by the States is not a new phenomenon, some programs are in fact well documented, and although officially condemned, they have been tolerated and kept secret in the past in the name of national security. The stealth nature of existing military technologies mean that we may never be able to prove that they are still ongoing, let alone defend the population. The secret services and military contractors cannot continue to operate above the law - police forces must have access to the technology to protect the people. Military circles are ruled by obedience, and the compartmentalisation of their work mean that some staff may either not know enough to blow the whistle, or

may wilfully want to remain ignorant in order to avoid personal responsibility and risk. The subcontracting of work to military contractors can also lead to the creation of grey areas in terms of responsibility.

Indifference cannot be tolerated. Apart from military staff and contractor workers, experimentation programs historically have involved specialists from across all disciplines, psychiatrists, psychologists, neurologists, linguists, etc. and some academics, too.

It is not possible then to believe that such ignorance and indifference about cybertorture and directed energy weapons exist in the medical profession and in society at large. Various morally flexible, highly educated professionals provide their services to the states most probably lured by utilitarian gains and acting not only against the law, but against any moral value, their Hippocratical oath and other professional ethics. Wilful justification, diffusion of responsibility and utilitarian moral disengagement may all play a role in this. And fear, I would add, since any unchecked power represents a threat for anyone who dares to oppose it. You can either be on the right or wrong side of the technology.

We need the States to challenge the unchecked power of their secret service and military contractors, investigate on what is being done and grant the police the power to protect the people from their own governments.

The police forces have no information and no access to these technologies

██████████
Previously a Captain in the United States Air Force
6+ Years of Active Service; 11+ Years of Total Service

Psychosocial Dynamics Conducive to Torture and Ill-treatment

Background:

- Since 2016, I have been subjected to Counterintelligence Disruption Campaigns. These operations have little separation from domestic terror activities and operations. In fact, they seek to create illicitly defined “enemies” for the express purpose of justifying their own existence and ever-expanding budgets. These disruption campaigns directly involve sleep deprivation, noise harassment, invasion of privacy, psychological / no-touch torture, 24/7 surveillance, constant stalking, and “mobbing.”

The relevant psychosocial dynamics conducive to torture and ill-treatment :

- Much of what occurs is because the perpetrators have a sense of being above the law due to their activities being covered under the guise of absolute secrecy, non-disclosure agreements, and national security. They exert a perverted form of patriotism, in which they “are the law” and civil society is subverted into enemy combatants. Those involved see themselves as being above the law and not accountable to the Constitution because they are serving the “greater good.”

Recommended normative, institutional and policy measures of prevention and mitigation:

- All programs operated against the public and citizens of their own nations must be disclosed. If national blacklisting, neighborhood watch programs, and disruption campaigns are to occur, then the public they “service” must be aware of these activities. The morality and legality of their existence whatsoever is beyond question, especially considering the torture apparatus they utilize when exerted en-masse, however oversight of non-partisan individuals outside of the industries in which their subordinates operate is crucial in assuring a return to the “rule of law” by those most sworn to uphold it. The formerly incarcerated must also be free of the binds of their former punishment, fully-abled to seek freedom of employment and upward mobility having served their “debt to society.” Western prisons of a medieval nature must also be destroyed, with a renewed focus on actual corrections and return to productive civil society.



People Against Covert Torture & Surveillance, International
PO Box 1925
Twentynine Palms, CA 92277
Website: www.pactsntl.org
Email: info@pactsntl.org

June 21, 2020

Dear Mr. Melzer:

I am President of a human rights organization called People Against Covert Torture and Surveillance, International. We were formed to assist targeted individuals with situations that amount to psychological torture and/or cybertorture as coined by your office. We feel it is important that our society realize that there are organized groups of people who intentionally target others for torture or ill-treatment for a variety of reasons and often for no apparent reason at all.

The torture most often manifests with some type of directed energy weapon or microwave weapon attack similar to what happened to the United States diplomats to Cuba and China recently. It is widely believed by doctors and scientists that they suffered and are still suffering from the effects of microwave weapons. This same scenario, however is happening to perhaps millions of people globally with often very serious health effects, such as heart attacks, strokes, cancers, headaches, blurred vision, sleep deprivation, loss of balance, impaired speech, memory loss, breathing difficulties, muscle cramps, and more.

The 24-hour surveillance and harassment activities that often accompany the weapons attacks amount to psychological torture and manifest in the following ways: workplace harassment, vehicular stalking, staged accidents, group stalking, surreptitious home entries, appliance tampering, vandalism, computer hacking, sabotage of relationships with family and friends, compromise of business contacts and much more.

We believe the source of these attacks to stem from federal government agencies and major corporations, as explained to us a few years ago by a corporate whistleblower who defected from a company that he claims performed such targeting upon homeless men and innocent citizens in the Seattle, Washington area.

We have attempted resolution of these issues through legislators in our United States Congress, as well as state, and local officials, however, most seem to be unaware of the existence and importance of addressing our claims. This hesitance to acknowledge our predicament has led to the perpetuation of this covert targeting program and to the continued suffering and actual physical and/or psychological torture and ill-treatment of tens of thousands of targeted individuals in our global community.

We look forward to whatever investigations your office can provide in this regard and appreciate the continued liaison between yourself and our colleagues Magnus Olsson and Henning Witte in the days ahead.

Thank you in advance for all your efforts to uncover the international criminal phenomenon of cybertorture.

Peace & Liberty,



Derrick Robinson, Executive Director
People Against Covert Torture and Surveillance, International
www.pactsntl.org
derrickcrobinson@gmail.com
513-568-1635

Tim Cassella, Board Member
PACTS, International
Las Vegas, Nevada

Louis Fournier, Ph.D, Harvard University
Moncton, New Brunswick, Canada

Ursula J. Barboza, Attorney-at-Law
Henderson, Nevada

Nancy Miller, RN
Fayetteville, North Carolina

Gloria Sterling, Managing Editor
"THE DISCUSSION" Magazine
St. Louis, Missouri

Lorraine Valente, MS, ACH, RMT
Unites States of America

Michael Onst
USAF Veteran
Retired Police Officer
Martial Artist
Targeted Individual
Arlington, Indiana

Minister Barbara Hyseni
Deland, Florida

Melanie Vritschan, President
International Coalition Against Electronic
Torture and Robotization of Living Beings
(ICATOR)
Brussels, Belgium

Dr. Millicent Black, MMFT
Columbia, Tennessee

Tracy A. Wellons, BA
Carlsbad, California

Serena Washington, Publisher
"THE DISCUSSION" Magazine
Houston, Texas

Deborah Todd
Former Police Officer
Virginia Beach, Virginia

Rosanne Schneider
Sebastopol, California
Author, "Surveillance, Torture and Control in the
Modern World"

Tom McClelland
Bronx, New York

Edith Harrison
Human Rights Activist
Detroit, Michigan
Woodrow Preacely
Whistleblower and Politically-targeted Individual
New York City, New York

Rametha Johnson
Cleveland Heights, Ohio
10+ years of torture & sexual assaults

Delores Hall
Irvine, California
Andrew Jonathan Dill
Texas, City, Texas

TJ Kohler
Klamath Falls, Oregon
V2K Victim

Kathleen Kohler
Klamath Falls, Oregon

Celia Harrison
Boise, Idaho

Joao Paolo Ferreira Dias
Sao Paulo, Brazil

Yusuf Rasheed
Stone Mountain, Georgia

James Killick
St. Albans, United Kingdom

Brian Eichstadt
Plymouth, Michigan

Yvette Basica
Los Angeles, California

Julie Wordsman
Oklahoma

Laura Solway, Filmmaker & housewife
Shoreline, Washington

Angelique Morrison
Las Vegas, Nevada

Cathy Clemens
Running Springs, California

John Reilly
Portland, Oregon

Maree-Lauren Hunter
Calgary, Alberta, Canada

Stephen O'Neill
Sligo, Ireland

Allison Ireland
Auburn, New Hampshire

Marina Abramycheva
Brooklyn, New York

Michelle Balatbat
North York, Ontario, Canada

Mr. Roger German
Decatur, Illinois

Ellen Hiscox
Schenectady, New York

Dorothy King
Bear, Delaware

Brian Linebaugh
Tampa, Florida

Markanthony King
Miami, Florida

Professor Nils Melzer
Special Rapporteur on Torture and Other Cruel,
Inhuman, or Degrading Treatment or Punishment
Office of the UN High Commissioner for Human Rights
52 rue des Pâquis
CH-1201 Geneva, Switzerland

21 June 2020

Re.: Response to RFI for Report on Psychosocial Dynamics Conducive to Torture

[submitted 21-Jun-2020 at 11:30 pm local time (east coast USA); 2,000 words total]

Dear Professor Melzer,

I am submitting this response to your request for information on behalf of a grassroots human rights organization known as FFTI. This is a joint response from me and Mrs. Ella Free. She and I are the co-founders of FFTI and serve as FFTI's president and vice president, respectively.

We are stakeholders in the psychosocial dynamics conducive to torture, as well as recommended measures to prevent and mitigate torture, for the following reasons. Our organization engages with and advocates for approximately 15,000 people in the USA and other countries who allege being victims of organized stalking and harassment, remotely delivered directed-energy assaults, and related forms of persecution and ill treatment. A sizable proportion of the victims we engage with have shared and documented accounts of abuse ranging from psychological harassment to bona fide psychological and physical torture with directional energy-emitting devices. In addition, Mrs. Free and I have firsthand experience as torture victims, which is what motivated us to engage in victim support and advocacy work. I was tortured by technology-assisted harassment and energy-weapon assaults from 1-Oct-2013 to 28-Jan-2016 in Vancouver, Canada, presumably because I witnessed criminal activity in a non-residential building next to my apartment. Mrs. Free is an ongoing victim of these forms of abuse, apparently because she rejected the advances of a wealthy, would-be paramour with connections to the high-tech industry. Consequently, we have firsthand expertise in these matters and a wealth of expertise garnered from the thousands of alleged victims with whom we engage regularly. We and our organization also represent civil society, as we are law-abiding, non-violent members of our communities.

Relevant Background

There is ample scientific literature and other documentation showing that directed, pulsed radio-frequency/microwave energy is capable of causing pain sensations, impairment of muscle function including that of the heart, capillary damage and bruising, inflammation and burns, eye damage, potentially concussion without blunt force trauma (called "the immaculate concussion" by some medical experts), and various induced sensory phenomena like the Frey Hearing Effect — all in a remotely delivered fashion and even through walls, ceilings, and concrete floor slabs that are not well shielded against radio-frequency/microwave energy. Pulsed radio-frequency/microwave energy of sufficiently high power, which is lower than one might expect, can induce perceived buzzing sounds, high-pitched ringing, or complex naturalistic sounds, by slightly heating the brain with each pulse of energy. The standing pressure waves induced by pulsed heating of the brain propagate to the inner ear, producing privately perceived sounds via this effect.

The prominence of this phenomenon among certain US and Canadian government personnel stationed in Cuba, who reported directional energy assaults starting in late 2016, prompted government agencies and the media to report those incidents as assaults with "sonic weapons". Two medical studies found evidence of neurological damage and brain tissue changes in those victims due to this incident:

- Swanson et al., 2018. JAMA 319: 1125-1133, [doi: 10.1001/jama.2018.1742](https://doi.org/10.1001/jama.2018.1742).
- Verma et al., 2019. JAMA 322: 336-347, [doi: 10.1001/jama.2019.9269](https://doi.org/10.1001/jama.2019.9269).

Given the distinctive symptoms experienced by those victims, a UC San Diego MD-PhD scientist, who has extensive expertise in bio-effects of non-ionizing radiation, recognized manifestations in the government personnel as being caused by radio-frequency/microwave energy:

- Golomb, B.A., 2018. Neural Computation 30: 2882-2985, [doi: 10.1162/neco_a_01133](https://doi.org/10.1162/neco_a_01133).

Over many years, militaries around the world have been developing directed-energy weapons for crowd control. Similarly, through-the-wall (TTW) radar devices (known as “radiolocators” and “intentional radiators” by the US Federal Communications Commission) are under active development for use by emergency services. Development of such technologies continues to progress in terms of increasing stand-off distance and decreasing size.

Dangers of Assuming That Only Militaries and Intelligence Agencies Are Capable of Deploying Harmful Energy-Emitting Devices for the Purpose of Torture and Ill Treatment

The assaults on the US and Canadian government personnel in Cuba were actually covered by the mainstream press — though with much controversy and confusion due to the difficulty of collecting residual forensic evidence — because those assaults were carried out simultaneously against a cluster of prominent and credible individuals. Taken together, the military development of directed-energy weapons and the assaults on the diplomats in Cuba lead most people to conclude that only militaries and intelligence agencies of wealthy nations are capable of carrying out such assaults. Yet, according to thousands of victims from ordinary walks of life, similar assaults are reported as being carried out by organized criminal groups within communities. Although this “backyard terrorism” is now reported as occurring in numerous communities across many nations, ordinary victims universally fail to get media coverage, medical documentation of assaults, or police assistance, or their allegations are regarded as manifestations of conspiracy theory “echo chambers” or mental illness.

While militaries, intelligence agencies, and certain sectors of law enforcement are certainly capable of deploying directed-energy weapons against targeted persons — with little or no accountability — it is dangerous to assume these capabilities are limited to such entities. The problem of torture and ill treatment with directed-energy devices is much more widespread than the Cuba incident. The manufacturers of high-power microwave generators, antennas, waveguides, and associated radio-frequency hardware, which supply components to military contractors, the telecommunications industry, and the medical devices sector, produce a massive catalog of commercial off-the-shelf technology. Components of that technology can be assembled or adapted into harmful devices, including devices to facilitate stalking, invasion of privacy, abuse, physical assault, and torture. The resulting directed-energy devices are increasingly available to criminals through various marketplaces.

Assuming that torture by means of directed energy is only a capability of state actors poses a danger to civil society. This assumption facilitates inaction by law enforcement, in turn facilitating the unfettered growth of a new mode of within-community torture and “backyard terrorism”, which are already being carried out with impunity by lone-wolf criminals and organized criminal groups. With this background in mind, we comment on the relevant psychosocial dynamics conducive to torture and ill treatment via directed-energy assaults and organized stalking. We also make recommendations concerning the prevention and mitigation of these activities.

Relevant Psychosocial Dynamics Conducive to Torture and Ill Treatment

Directed-energy assaults are highly invasive and deeply violating, because they can be remotely and covertly delivered to targeted victims going about their daily lives in community settings (e.g., via devices covertly mounted on automobiles) or while victims are at home (e.g., via equipment deployed in neighboring homes). This leaves victims feeling there is nowhere to escape the abuse. Moreover, organized stalking typically involves the participation of a large number of networked offenders. Isolated instances of harassment are distributed among many offenders, such that each offender may feel a sense of little or no culpability. In contrast, victims suffers the entire onslaught of abuse during protracted harassment campaigns. Both organized stalking and directed-energy abuse are facilitated by advancements in commercially available technology. In regards to the specific examples of organized stalking and directed-energy assaults, we identify the following psychosocial factors associated with torture and ill treatment:

1. The ability to deliver abuse and torture remotely and anonymously seems to dampen many offenders' feelings of empathy and shame, which would otherwise inhibit more proximate and public acts of torture and ill treatment. So pronounced are these psychosocial drivers that many victims report their harassment and abuse as appearing to have no discernible motive other than antisocial entertainment on the part of the offenders.
2. Torture and ill treatment within communities is facilitated by methodologies that allow multiple offenders to make small piecemeal contributions to a much larger campaign of abuse directed against targeted victims. Psychologically, this shared culpability allows each offender to feel that their contribution to the torture is not immoral or criminal.
3. When technology and/or criminal methodology allow torture to be carried out within seemingly civil society — in everyday contexts and in a difficult-to-document manner — law enforcement, medical care practitioners, and even victims' families and friends are unmotivated to provide services or support. "Institutional betrayal" of victims, including forced psychiatric examination and forced medication in extreme cases, magnify the trauma and harm experienced by the victims.
4. Unwitting bystanders find it extremely difficult to accept that such disturbing criminal activity may be occurring in an invisible manner in their midsts. Accepting this possibility would destroy their feeling of safety and wellbeing. Owing to society's deeply enculturated responses to allegations of covert harassment and torture by means of futuristic weaponry, we should actually expect the criminals to adapt their methodologies and technologies to exploit these very same reflexive responses by the bystander audience.

Recommended Measures of Prevention and Mitigation

The core issue underpinning the psychosocial dynamics conducive to torture by covert methods and technologies which leave little trace is the difficulty of convincingly documenting such torture for the wider audience of civil society. Surely, the vast majority of society would never want such atrocities to pose risks to their families, friends, and fellow citizens. With this in mind, we make the following recommendations to prevent and mitigate novel technology-assisted forms of torture and ill treatment:

1. *Establish policies that encourage member nations to comprehensively investigate allegations of torture and ill treatment by non-state actors, criminal groups, or rogue state actors, whenever a threshold number of citizens make such claims.* Given the rapid development of technology, and recognizing that harm can be delivered in ways that leave little or no trace, the motivation behind such investigations should not hinge on victims producing physical evidence. Recognizing there are technologies that can be used to torture in ways that are unfamiliar or intangible — or produce bizarre effects on victims'

senses, perceptions, or minds — investigations into allegations of torture and ill treatment should not be discouraged by victims' difficulties in describing their experiences as recipients of torture and ill treatment. The burden of fact finding and evidence gathering must fall on law enforcement and the state whenever a sizable population of citizens alleges torture or ill treatment, even if their allegations are difficult to make sense of.

2. Establish policies to encourage member nations to invest in forecasting the possible applications of novel and existing technologies to the torture and ill treatment of citizens and residents by non-state actors, criminal groups, or rogue state actors. When potential modes of torture are predicted, the same policies should encourage investment in the development of practical and affordable measures to assist ordinary individuals in documenting their torture or ill treatment in ways that have evidentiary value in jurisprudence. This recommendation should be motivated by the facts that criminals are often among the first to adopt new technologies for illicit gain and that forensic science typically lags advancements in criminal tactics.

Thank you for considering our recommendations.

Sincerely,



Matthew E. Arnegard, Ph.D.
Vice President of FFTI

on behalf of Mrs. Ella Free,
President of FFTI, and our organization:
www.freedomfortargetedindividuals.org

Attachments (3 photos):

1. Concentric ring resonator waveguide impression in window of Arnegard's apartment in Vancouver, Canada from directed-energy assault with witnessed high-power microwave generator (20-Dec-2015; video also available).
2. Waveguide impressions in window of an FFTI volunteer in Arlington, VA, USA, from directed-energy assaults in February 2018 (markings also witnessed and verified by Arnegard in 2019 and again in 2020).
3. Military vehicle with millimeter wave crowd control weapon at 17th and L St. NW, Washington DC, during "Black Lives Matter" protest on 6-Jun-2020 (photo by M.E. Arnegard).

Waveguide impression (i.e., beam cross-section) flash-burned and frozen (i.e., dielectrically engraved) in window of Apt. 1501 at 1189 Howe St. (Vancouver, BC) from directed-energy assault (w/witnessed beam weapon) at approx. 10:00 pm, 20-Dec-2015. Photo by M.E. Arnegard at 3:04 am on 21-Dec-2015.

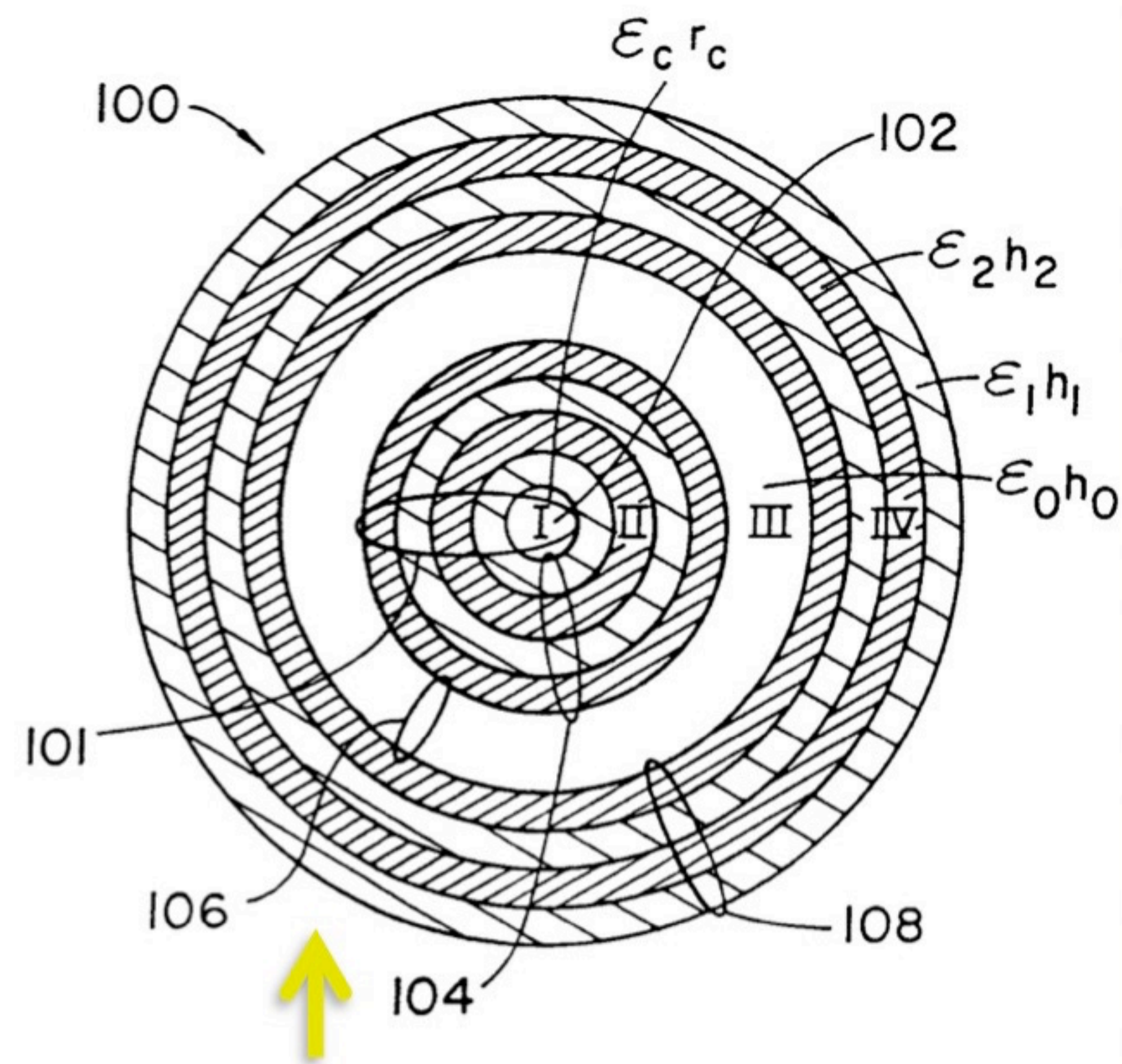

Example of concentric ring resonator waveguide (Fig. 1 from patent US 6573813 B1)

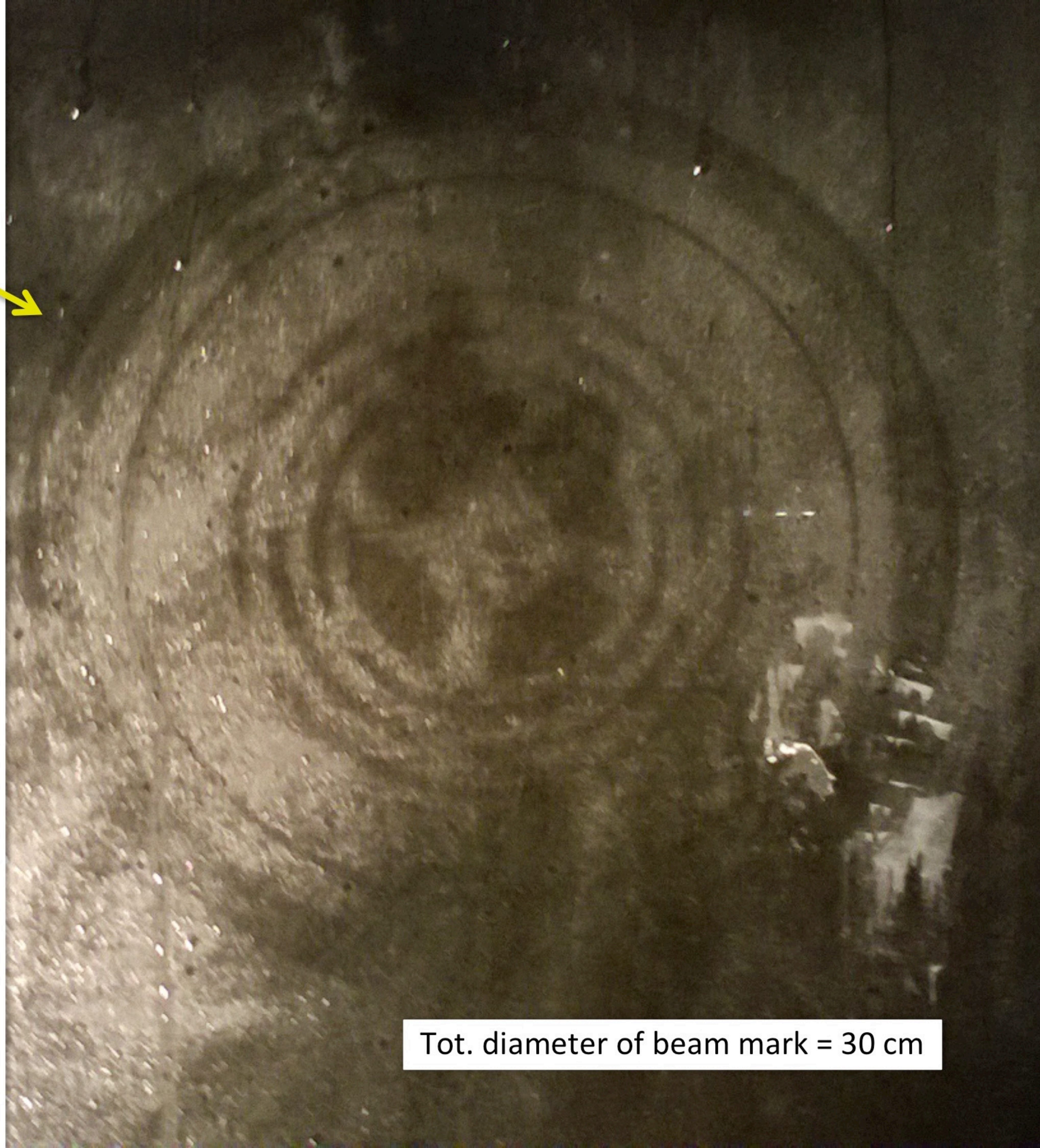

Tot. diameter of beam mark = 30 cm





Information Weapons: Russia's Nonnuclear Strategic Weapons of Choice

Timothy L. Thomas

INTRODUCTION

For many years now, Russia has defined and even expanded its concept of “information weapons (IWes).”^[1] At one point, Russia attempted to get the concept introduced into United Nations resolutions, which at the time helped to guarantee Russian information and national security. This occurred in the 1990s when Russia was at its weakest and unable to compete with other nations in information warfare capabilities. At this time, Russia’s information warfare weakness was so pronounced that a prominent Russian scientist stated the following at an international conference in Moscow in 1995:

In studying the potentially catastrophic consequences from an enemy’s use of strategic information warfare systems on, for example, the economy or government control...we must unequivocally declare that in the case of their use against Russia, we reserve the right to conduct a first strike (nuclear) against the information warfare system and forces which are directing that weapon, and then also against the aggressor-government.^[2]

This stark warning was intended to send a message to other nations, and it served its purpose well. “Don’t mess with Russia” if you want to keep Russia from messing with you.

Since the revival of Russia’s military prowess, a variety of its authors have continued to focus on information-related topics, to include the following: information warfare, information struggle, information resources, information confrontation, information sphere, information field, information effects, information superiority, information security, and, in line with the focus of this article, IWes. At times, IWes address the information-related technologies used in precision-guided and reconnaissance type weaponry, and at other

© 2020 Timothy Thomas

Approved for Public Release. The views expressed in this document are those of the author and do not reflect the official policy or position of MITRE, the Department of Defense, or the U.S. Government.



Timothy L. Thomas is an analyst for the MITRE Corporation. He worked for 27 years at the Foreign Military Studies Office (FMSO) at Fort Leavenworth, Kansas. He retired from the U.S. Army as a Lieutenant Colonel in the summer of 1993. Mr. Thomas received a B.S. from West Point and an M.A. from the University of Southern California. He was a U.S. Army Foreign Area Officer who specialized in Soviet/Russian studies. His military assignments included serving as the Director of Soviet Studies at the United States Army Russian Institute (USARI) in Garmisch, Germany; as an inspector of Soviet tactical operations under CSCE; and as a Brigade S 2 and company commander in the 82nd Airborne Division. Mr. Thomas has done extensive research and publishing on military affairs about both Russia and China. He served as the assistant editor of the journal *European Security* and as an adjunct professor at the U.S. Army's Eurasian Institute, and was an adjunct lecturer at the USAF Special Operations School.

times IWes are presented more simply as weapons that help in the manipulation of social media and propaganda. The West seldom considers information to be a “weapon” as Russia does, nor does the West break the term into information-technical and information-psychological aspects.

The information-technical aspect of IWes includes technologies used extensively by Russia and many other nations in global positioning, reconnaissance, electronic warfare, and other types of equipment worldwide. The information-psychological aspect refers not only to Russia's use of information as an online weapon in the social and political arenas, which has become unsettling to Western audiences, but also to Russia's use of disinformation, fake news, non-governmental organizations, and a tendency to define objective reality as the Kremlin sees fit, and thus avoid “the truth.” Their use appears to be a modern version of Soviet active measures, which were operations developed years ago in Section A of the First Chief Directorate of the KGB. They aimed to shape operations abroad and influence events in another country and were often referred to as “political warfare.” Related terms were “assistance programs” or “assistance operations,” tactics designed to change the policy or position of a foreign government in a way that would “assist” the Soviet position. A Russian foreign intelligence officer who defected to the US in 2000 noted that there is no difference between “active measures” and “assistance operations,” and that when the KGB went away after the demise of the Soviet Union, the active measures office was renamed to assistance operations. Active measures reportedly were based on 95 percent objective information “to which something was added to turn the data into targeted information or disinformation.”^[3]

Thus, Russian IWes must be considered for its utility in military, political, and psychological warfare, plus also its utility in manipulating news and social media.

As a result, IWes have become non-nuclear strategic weapons of choice. This article will examine several Russian views of IWes that cover these aspects, beginning with the bigger picture of IWes as strategic weapons. That discussion is followed by an overview of the Russian military literature that has addressed IWes over the past two decades. The discussion includes theater information weapons, information-strike weapons, cyber weapons, and social-media weapons, among others. The analysis concludes with a very brief commentary by one Russian specialist about the next generation of weapons, such as quantum computing and artificial intelligence concerns.

THE BIG PICTURE: IWES AS NON-NUCLEAR STRATEGIC WEAPONS

IWes are considered non-nuclear strategic weapons in Russia due to their wide reach, even to continents far away (thus, a planetary weapon). According to Russian new-generation warfare expert Vladimir Slipchenko, IWes have also enabled a shift from a “quantitative-force sphere to a quantitative-intelligent sphere.”^[4] He adds that countries are creating “strategic non-nuclear forces, which will find wide use in new-generation wars and subsequently also will take on a deterrence function.”^[5] Numerous weapons depend on information technologies. Acoustic, electromagnetic effect, radiation, beam, and heat weaponry^[6] are under development as is the “unity of intelligence collection and destruction,” namely the development of reconnaissance-strike and reconnaissance-fire complexes.^[7] Slipchenko views the development of space groupings as a key shift as forces transition from a ground-based force to one based on aerospace and information. Intelligence collection from space will provide information that “will become the basis for planning massive high-precision strikes in the course of a strategic air-space-sea strike operation.”^[8]

Slipchenko’s thoughts coincide with a Russian concept known as the Strategic Operations to Destroy Critically Important Targets (SODCIT) as discussed by numerous outlets. In 2010, a *Red Star* article flagged changes in the nature of wars that would manifest in the various forms in which the Armed Forces are used: “SODCIT has been developed.”^[9] Retired Colonel General Viktor Barynkin added that “it has become expedient to combine strategic defensive and offensive operations and strategic operations in the ocean theater of hostilities into a single strategic operation.”^[10]

In conducting such operations, the expansive reach of IWes will play a crucial role. For example, as the Russian journal *Air-Space Defense* stated in 2013:

It is possible to use various space systems in support of each of these operations. Thus, supporting a strategic operation to destroy critically important enemy targets necessitates the use of space-based means of reconnoitering these targets; electronic intelligence assets; meteorological reconnaissance assets in the interests of a proper selection of attack weapons and their combat employment methods; and space-based navigation, communications, relay, and strike evaluation systems.^[11]

As noted, these assets rely on information technologies.

Thus, the term SODCIT implies the extended use of IWe as non-nuclear strategic weapons or assets. Such use in conjunction with aerospace forces or precision-guided munitions is significant since both possess long-reach capabilities into the depth of an adversary's territory anywhere on the globe. Russian planetary warfare theorists must find such concepts intoxicating. For Western analysts, SODCIT should raise concerns as to what Russia is planning.

How did Russia ultimately arrive at this conclusion that IWe provides a non-nuclear strategic capability? The following discussion that has transpired over the past two decades offers how the concept of IWe gradually evolved and incorporated new developments in information technologies, which in turn led to new ways to consider information-technical and information-psychological applications of IWe.

THE FIRST IMPORTANT IWE DISCUSSIONS

Detailed descriptions of IWe and their uses began to develop slowly in the 1990s. One of the first (and still considered outstanding) Russian articles to define and discuss an IWe is the article by Major S.V. Markov, which was authored and published in 1996 in the journal *Bezопасnost (Security)*. Leading specialists still refer to his many thoughts and definitions. Markov defined an IWe as:

A specially selected piece of information capable of causing changes in the information processes of information systems (physical, biological, social, etc.) according to the intent of the entity using the weapon.^[12]

This understanding of IWe and its impact on the information-technical and information-psychological activity of Russia produces a much different national will and language of dialogue than that to which the West is accustomed. Markov is convinced that international and state control over the creation and use of IWe is essential.^[13]

According to Markov, IWe can be used in the following ways:

- ◆ To destroy, distort, or steal data files
- ◆ To mine or obtain the desired information from these files after penetrating defense systems/firewalls
- ◆ To limit or prevent access to them by authorized users
- ◆ To introduce disorganization or disorder into the operation of technical equipment
- ◆ To completely disable telecommunications networks and computer systems and all the advanced technology that supports the life of society and the operation of the state^[14]

In 2000, the work of five authors at the Institute of Systems Analysis superseded Markov's IWe article in importance. They wrote the first authoritative, detailed introduction to, and explanation of, IWe in a pamphlet titled *The Information Weapon—A New Challenge to International*

Security,^[15] which describes various forms of IWes. One author, Andrey Krutskikh, became President Putin's point man on cyber issues and where he continues to serve today.

These authors classified IWes based on several attributes to include single and multi-mission/universal purposes; short- and long-range operations; individual, group, and mass disruption or destruction capabilities; various types of carriers; and destructive effect. They further classified IWes as belonging to one of six forms:

1. Means to precisely locate equipment that emits rays in the electromagnetic spectrum and destroy that equipment by conventional fire
2. Means to affect components of electronic equipment
3. Means to affect the programming resource control modules
4. Means to affect the information transfer process
5. Means to disseminate propaganda and disinformation
6. Means to use psychotronic weapons

The pamphlet then discussed the significance and potential types of each of these weapons. The authors analysis of the fifth and sixth forms, which, because they are less prominently covered in the Western press, merit discussion. The fifth form, propaganda and disinformation, can change the information component of command and control (C2) systems by creating a virtual picture that alters reality, changes the system of human values, and manipulates the moral-psychological life of the enemy population. This type of weapon can create disinformation in secure systems and alter navigation systems, information and meteorological-monitoring systems, precision-time systems, and so on.

The sixth form, psychotronic weapons, describes weapons that leverage psychology and the subconscious to attack a person's will, and otherwise suppress and/or temporarily disable or zombify that person. These weapon types include:

- ◆ Psycho-pharmacological substances
- ◆ Psycho-dyspeptics
- ◆ Tranquilizers, anti-depressants, hallucinogens, and narcotics
- ◆ Specially structured medicines
- ◆ Special-beam generators that affect the human psyche
- ◆ Special video graphic and television information
(25th frame effect, elevating blood pressure, inducing epileptic seizures, etc.)
- ◆ Means for creating virtual reality that suppresses the will and induces fear
(e.g., projecting an image of "God" onto clouds, etc.)
- ◆ Technologies of zombification and psycholinguistic programming^[16]

The authors note that information technologies can serve as IWes, which are integral components of high-precision ammunition that can be used to guide missiles via position finding and reconnaissance, as well as by visual, electronic, and other means.

MOVING ON: INTERESTING 2001-2019 DISCUSSIONS

Russia's perception of the West's focus on noncontact warfare and advanced cyber weapons in the 1990s led Russian theorists to conclude that adversaries wanted to develop a "clean" war run by special agents and programmers against a still vulnerable Russia. This led Russian authorities to envision IWes as helping to offset the Kremlin's national security weaknesses. Russian theorists saw the many benefits of IWes and praised them for their universality, covertness, and variety of implementation forms (software and hardware), their radical effects and ability to select a precise time and place of employment, and, finally, their cost-effectiveness. But recognizing these attributes also raised concerns for Russia's national security,^[17] since other nations were farther along in IWe developments.

The following discusses specific elements of Russia's focus on IWes over the past two decades and demonstrates the growing importance of the concept and how it has been integrated, through Russian eyes, into information warfare and its information-technical and information-psychological components; and how IWes have underscored the growing importance of nonmilitary means to influence and win confrontations.

In 2001, the PIR Center in Moscow published a paper that included a key chapter on IWes, noting that, like the military, information superiority now determines battle outcomes. Invariably, the first to process battlefield information is less vulnerable. Disabling an opponent's command and control systems is key to information superiority. IWes can be high-precision weapons, electronic warfare assets, electromagnetic pulse weapons, or software viruses, among others. The paper noted that an IWe's effectiveness in achieving information warfare missions is often pivotal.^[18] The authors then discussed the same six IWe types and their characteristics and effects as were discussed by the 2000 IWe pamphlet authors—no surprise, because one of the 2000 pamphlet authors also coauthored the PIR Center report (V.N. Tsygichko). IWe effects were divided into three areas: information technologies (as components of munitions and reconnaissance, propaganda, and software systems), energy (as components of EW, microwave, and cruise, or unmanned aerial vehicles), or chemical (gases, aerosols, pharmacologic agents, etc.).^[19] Several other IWe advantages included general freedom of access to many information systems, especially in social media; the blurring of traditional legal and ethical borders (are we witnessing a crime or an act of war?); the difficulty in controlling perceptions due to the wide range of "facts" available; and the potential for the covert preparation of a battlefield years in advance through the placement of specific software.^[20]

In 2002, in an important article in *Armeyskiy Sbornik* (Army Journal) by Vladimir Slipchenko, who used the term "new-generation warfare" as early as 2000, noted that information's role

will only grow in the coming century. IWes will be system-destroying, he noted, as they will disable entire combat, economic, and social systems, rendering them an effective non-nuclear strategic weapon. Offensive means include destroying or disrupting an adversary's information infrastructure, his process of operational command and control, and attacks on computer networks. Defensive measures include operational and strategic camouflage, physical defense of information infrastructure facilities, disinformation, electronic warfare, and other means. Slipchenko added that electronic suppression would remain the most important component of a nation's information resources, predicting they eventually would become an independent countermeasure. He also flagged cybernetic warfare as a promising potential element of independent development.^[21]

Also, in **2002**, two authors described IWes as nonlethal weapons (NLWs), noting the development of the mass media as an information NLW prerequisite. Of interest is that psychological NLWs also were considered as IWes but had not yet been scientifically confirmed. These NLW types included telepathy, telekinesis, clairvoyance, and other psychological means,^[22] all measures under study in Russia for decades but have yet to produce known discernable results.

In **2003**, an article in the journal *Military Thought* noted that the Cold War's end brought with it a desire to eliminate many weapons of mass destruction. This caused the military to focus more attention on precision-guided and other IWes, both lethal and nonlethal. The Persian Gulf War, the article noted, integrated precision-guided weapons with global navigation, intelligence, communications, command and control, and electronic warfare systems and created theater information weapons (TIWes). Specialists began to consider information-strike operations, whereby a force could achieve military objectives without land forces. These authors viewed TIWes as the information-technical component of IWes. The information-psychological component, on the other hand, is designed to break the enemy's will to resist, where the main targets are troop morale, public opinion, and the decision-making systems of the opposing side,^[23] to include using psychotropic substances or manipulative information amid distracting messages. New technologies increase the opportunities to develop and use such effects as neuro-linguistic programming.^[24]

In **2007**, Sergey Ivanov, Russia's Defense Minister from 2001 until 2007, noted the important potential of IWes to influence the conduct of future wars. He was particularly impressed with the widespread applicability of IWes in conducting operations without becoming involved in a military conflict:

The development of information technology has resulted in information itself turning into a certain kind of weapon. It is a weapon that allows us to carry out would-be military actions in practically any theater of war, and most importantly, without using military power.^[25]

In **2011**, two Russian military specialists wrote on information-strike operations in the journal *Armeyskii Sbornik (Army Journal)*. They viewed the classic triad of fire, strike, and maneuver as no longer capturing the essence of a battle or operation. Radio-electronic, electronic-fire, and

information-strike operations were the new forms of armed struggle. The latter is particularly important as defined below:

The information-strike operation (ISO) is the totality of mutually associated information strike engagements (*srazhenie*), information-strike battles (*boi*), and information strikes (*udar*), coordinated with respect to goal, missions, place, time, and method of conduct, carried out with the aim of disorganizing an adversary's troop and weapons command and control system and destroying his information resources.^[26]

IWes conduct information strikes against an adversary's information resources. The types of strikes include information-psychological (which disinform or mislead an adversary), information-psychotropic (to disrupt a person's psyche), radio-electronic, and program-computer. ISOs help gain information initiative and superiority, including command and control of troops and the adversary's reflexive control. ISOs have no spatial limitations, a variety of forms and methods of use, no weather or seasonal constraints, can often be used covertly, and can target command posts and communication nodes.^[27]

ISOs can be conducted in three stages. First, information support systems of command and control for intelligence, air defense, and rocket defense are disorganized. Second, under the cover of jamming, destructive strikes are made—operational-tactical and tactical rockets. Third, information support of tactical and army aviation and field artillery is disorganized.^[28] To prepare an ISO, an adversary's command and control system must be studied and exposed, and objectives for fire and radio-electronic destruction determined in advance. Disorganizing the enemy's command and control system is critical to planning and coordinating friendly fire destruction elements.^[29]

The authors then note the various types of information-psychological weapons that will enhance an ISO, and energy-information-psychological weapons under study for ways to modulate super high frequency ultrasonic infrared waves that affect the human nervous system. Psychotropic-information weapons use narcotics and chemicals to produce information-control effects on biological processes and the nervous system. Technical means (e.g., generators) of virtual information-psychological and other types of weaponry offer different potential capabilities to affect the human psyche (author's note: no actual results were offered, just these theories). Information-psychological weapons are to be integrated with fire, radio-electronic, and energy effects to broaden the operational-strategic methods for achieving ISO goals. The ISO is basically an offensive action, but it can acquire a defensive character if needed.^[30]

An influential 2012 article entitled "Information Weapons: Theory and Practice of Their Employment in Information Warfare" views the infosphere as an inexhaustible information space, supply and replenishment source, and one that also features the compactness of information carriers, and bloodless responses—all infosphere features that have exponentially intensified information warfare. IWes can at least be partially kept secret, can cross borders and impact sovereignty, and can be used in both military and civilian structures. More importantly, the

authors stated that IWeS cause the greatest losses when used against command and control systems and the human mind.^[31]

The authors classified IWeS according to effects, which they termed as physical, informational, software, or radio-electronic. Physical effects included specialized storage batteries for high-voltage impulses, the means to generate electromagnetic impulses, graphite bombs, and microbes that interfere with electronic circuits and insulation materials. Information effects included mass information resources, global networks, and voice “disinformation” stations. Software attack weapons included computer viruses, logic bombs, and the means to suppress information exchanges. No radio-electronic effects were offered. However, “dynamic IWeS” were defined as a “unified system of comprehensive, combined, beam, targeted, and strike employment of all forces and means of technical, communications, and information-psychological effects against the subconscious of the objective of the attack.”^[32] Methods for implementing dynamic IWeS are mathematically, algorithmically, or software-hardware based, and are most effective when employed as a set in offensive, defensive, or support forms.^[33] The authors noted that information-psychological effects result from:

A purposeful psychological attack against concrete areas of the human mind, the minds of a group of people, or the public consciousness as a whole. Effects can be implemented with respect to the means of information stimuli by using the entire spectrum of methods and forms of technical, visual, aural, medical, physical, painful, and virtual suppression of the will.^[34]

Electromagnetic weapons (EMW) are well-known for disrupting or interfering with information system operations. They can disrupt a country’s economy, production, and defense capabilities. Disrupting systems that exchange information for command decisions can have serious consequences. C4ISR is the main target of EMW effects. It was noted that “the principle of EMW action is based on short-term electromagnetic radiation of great power, capable of incapacitating radio-electronic devices that comprise the basis of any information system.”^[35]

The authors conclude as follows:

Universality, covertness, variety of the forms of software and hardware implementation, the radicalism of effects, adequate choice of time and place of employment, and, finally, cost-effectiveness make IWeS extremely dangerous. They are easily camouflaged as protection resources of, for example, intellectual property. They make it possible to even conduct offensive operations anonymously, without a declaration of war.^[36]

Near the end of 2012, S.G. Chekinov and S.A. Bogdanov defined the initial period of war (IPW) in *Military Thought*, as the time when forces are deployed pre-conflict, to create favorable conditions for committing their main forces. Under the new military, political, and economic conditions, the authors attribute special significance to IPW for winning a conflict:^[37]

The IPW may become the hardest phase in which the warring sides will be striving to make the most of the power of its groups of forces built up in advance and deployed in secret to achieve the main goals of the war. This period will be the most critical phase of the war and have a great effect on its outcome.^[38]

Of interest are malware and other information technologies secretly placed in the infrastructure or computers of potential opponents in peacetime that would help accomplish some of the main means for winning a war, such as totally upending an opponent's command and control system. Such technologies are IWes. The authors noted that "major military, political, and strategic objectives of the war must be achieved in its initial period."^[39]

In early November **2013**, the State Duma Security and Anticorruption Committee recommended amending a Federal Security Service (FSB) law to allow police investigations to counter threats to Russia's information security, such actions previously permitted only as to state, military, economic, or environmental security threats. The report indicated that harmful software, for example, can be used as an information weapon^[40] that could threaten security. That same year, Russia's Security Council noted that information and communication technologies are a looming threat as IWes, since they can threaten strategic stability, violate the territorial integrity of other nations, and act in both the military and political spheres of interest.

In **2013**, Chekinov and Bogdanov discussed new-generation warfare, highlighting on numerous occasions the importance of information technologies,^[41] noting that "decisive battles in new-generation wars will rage in the information environment," where computer operators will manipulate computers far away from the conflict. Information operations will induce world public opinion to accept the need to restore democracy and fight tyranny.^[42] Once information superiority is achieved in peacetime; conflict may even be avoided. If a conflict appears inevitable, it is visualized information technologies will heavily influence and possibly dominate its opening phases, as there will emerge a targeted information operation, an electronic warfare operation, and high-precision weaponry loaded with information technology.^[43]

In **2015**, at a presentation in Garmisch, Germany, noted Russian information warfare experts I.N. Dylevsky and S.A. Komov offered a paper titled "Rules of Conduct in Information Space—An Alternative to an Information Arms Race," noting that "[a]nother aspect of confrontation in the information sphere is a rapid advancement and proliferation of information weapons."^[44] Their use can lead to industrial disasters or, worse yet, critical infrastructure (finance, energy, transport, etc.) destruction. The authors, while urging that it was time to adopt universal laws to prohibit their development,^[45] did not expand on how this could be done, or how nations could control the risk of their development elsewhere.

Later that year, *Military Thought* described nonlethal weapons (NLWs) as effective information warfare assets, implying their potential as an IWe. In handling internal issues, NLWs can "defuse the bellicose moods stoked by propaganda and isolate the most outrageous advocates of the indiscriminate use of military force."^[46] Ironically, the "mood" of recent anti-Kremlin

demonstrations in Moscow was provoked or exacerbated by the Kremlin's decision to keep certain people off election ballots. So, moods can either be "provoked" or "defused" (with NLW) by the same government officials.

Russia's *National Security Strategy*, published in 2015, referred 36 times to the term "information" without ever mentioning the term "cyber." The primary use of information, it seems, is as an instrument "set in motion in the struggle for influence in the international arena" (along with political and financial-economic instruments). The *Strategy* reported that confrontation in the global information arena is "caused by some countries' aspiration to utilize informational and communication technologies to achieve their geopolitical objectives, including by manipulating public awareness and falsifying history." Information is also mentioned as one way to enhance strategic deterrence. Information associated with extremism or terrorism is taken to be a significant threat to public security and, countering such threats requires an information infrastructure that ensures the public's access to information on issues relating to the sociopolitical, economic, and spiritual life of Russia's citizens.^[47]

In 2016, during his annual speech at the Academy of Military Science, General Staff Chief Valery Gerasimov discussed the impact of so-called "color revolutions" and how their utility could be quickly furthered through the adaptive use of information resources as a weapon:

Essentially, any "color" revolution is a state revolution organized from without. Their basis is information technologies, which envision the manipulation of the protest potential of the population in combination with other nonmilitary means. Here, mass targeted effects on the consciousness of the citizens of a state—the objects of aggression by means of the global "Internet" network—acquire important significance. Information resources have essentially become one of the most effective types of weapons. Their extensive use makes it possible to "shake up" the situation in the country from within in a matter of days.^[48]

"Information resources" the West uses against Russia, according to a *New York Times* source, are nongovernmental organizations (NGOs) and operations aimed at the young. For example, President's Putin's 2007 speech in Munich expressed concerns about NGOs, alleging they "are used as channels for funding, and those funds are provided by governments of other countries." That flow of foreign money to assist opposition political organizations in Russia, he said, is "hidden from our society. "What is democratic about this?" he asked. "This is not about democracy. This is about one country influencing another."^[49]

In 2017, Chekinov and Bogdanov shifted focus from new-generation wars to the importance of "new-type" warfare. stating that globalization threatens a "new type" of war, which could "become the pivot of historical life in the 21st century."^[50] New-type warfare is characterized using "political pressure, information sabotage, cashing in on humanitarian issues, secret-service activity, and unfair and cunning diplomacy."^[51] Earlier in the article, the authors addressed the growing impact of information warfare. Information operations use manipulated information, computers, and telecommunications technologies to suppress adversaries by disorganizing

command and control and introducing chaos into their work. This work misinforms army personnel and the population and psychologically crushes them.^[52] The realm of the virtual, both informational and cognitive, is exploited.^[53] Again, while not explicitly mentioning IWes, the article clearly views IWes as major components of new-type warfare.

In 2019, the journal *Vestnik Akademii Voennykh Nauk (Journal of the Academy of Military Science)* published an article on the impact of information processes on Russia's national security. It stated that the information society, globalized information processes, and the democratization and heightened importance of socio-political factors in society had created an information struggle. Internally, the struggle is about controlling large numbers of people. Externally, the information struggle rages both in times of peace and war among states, regardless of whether the states are allies or enemies. Twenty-first century struggles include a state's information capabilities, which work to achieve the strategic advantages^[54] that come from information superiority.

Information, the authors note, moves through space and time via processes of "searching, collecting, storing, processing, presenting, accumulating, disseminating, and decision-making."^[55] Depending on how information is used and where it is located (in military weapons technology, in a human mind, in command and control processes, etc.), it produces different effects (precise targeting, manipulation of data, etc.). The authors defined IWes as follows:

Information weapons are the totality of technical, software, and other special resources, constructively intended for the formation of information effects for the purpose of disrupting information processes by means of effects against the elements of an information resource (information target) by a special pattern of organized flows of emissions of energy of different physical natures or a specific pattern of selected and structured information.^[56]

The authors believe the concept of "means of information effects" more broadly describes the essence of IWes. Technical effects, linguistic and software products, and other means can produce effects against an opposing side's information resources. Effects used to gain information superiority against an opponent include radio-electronic warfare resources, software that disables automated C2 systems, psychotropic generators, special pharmacological means, and the mass media. Information superiority was defined as superiority in timeliness, reliability, and completeness attained by C2 organs for use in the processing and timeliness of decision making and control in the execution of plans.^[57]

A final 2019 article by a US author, discussed Russia's use of the "big lie," that is, Russia's tendency to define objective reality as the Kremlin sees fit and thereby avoid responsibility for the "truth." This is a different type of IWe. The article described Russia's recent admonition to Iran never to admit guilt in the downing of the Ukrainian airliner that it had recently caused. A deputy head of Russia's State Duma's Defense Committee noted that it was far more important to blame the US.^[58] This has been a typical Russian response to avoid responsibility at all costs,

even to the detriment of its own credibility. Russia is quick to openly deny complicity in any accusation leveled against it by other nations. To date, its responsibility for the shutdown of MH-17 airliner over Ukraine and its involvement (based on credible evidence) in the poisonings of former Russian intelligence operators Aleksandr Litvinenko and Sergey Skripal (both on UK territory) are such examples. So is its failure to accept responsibility for the doping of its athletes in the Sochi Winter Olympics, a charge first levied by a Russian!

FROM INFORMATION WEAPONRY TO KOKOSHIN'S TECHNOSPHERE

Now shifting attention from IWes to artificial intelligence (AI) and quantum computing issues, while these topics are beyond the scope of this article, their mention is important, given their significance in the continuing evolution of IWes.

Andrey Kokoshin, former Secretary of the Russian National Security Council and Deputy Defense Minister, is a renowned researcher on military and scientific issues. He wrote in a 2019 issue of the *Journal of the Academy of Military Science* that the military technosphere is a complex combination of technologies from several generations, and in several dimensions, that must be studied and used to forecast and implement change. These technologies will affect both operational and strategic plans. Various components of the technosphere, to include the combat and non-combat employment of forces and means, need to be assessed^[59] for how technical issues can strengthen or weaken their use. Crucial technosphere developments currently include AI and quantum computing capabilities, along with the use of information influence.

Kokoshin stated that the ability to impose information effects on an opponent, including political and psychological effects, can deter confrontations. Each effect relies on “a persuasive, carefully thought-out demonstration of our military-technical and operational-strategic capabilities.”^[60] Information confrontations can include fakes and deliberate disinformation, and these can contribute to an escalation of the situation and affect decision-makers. While never citing the term “IWes” directly, Kokoshin describes AI systems, robotics, and military confrontations in space all as information-based technologies, thus implying that they are IWes.

Kokoshin views AI's development strategy as complex, requiring consideration of uncertainty and risks: some (if not all) AI applications may have unexpected consequences, particularly when decision-making and command and control issues are at stake. Further, leaders need information as to political-military, operational-strategic, and tactical situations during information confrontations and struggles for cyberspace superiority. The last two issues must be included in war games to create a precedent for decision-making support systems.^[61]

Kokoshin also views quantum technologies and quantum cryptography as critically important. Because China may have the edge with quantum telecommunications network superiority, he also believes that China can perhaps deliver “a blow against the contemporary information-centric methods of waging war” that the U.S. Armed Forces have developed.^[62]

CONCLUSIONS

Russia is far removed from the days when it threatened the US with a nuclear attack if an information attack was conducted against the Kremlin. Russia now possesses its own arsenal of IWes, one with different forms than what the West is familiar with. Russia believes IWes are non-nuclear, strategic weapons capable of inflicting numerous types of destruction or influencing potential opponents, from disorganizing command and control and disabling critical infrastructure to manipulating and persuading public opinion and causing chaos in state administrations and electoral processes. Information technologies lie at the center of IWes and, while they can be found in the arsenals of most nations, they are used in different information-technical and information-psychological ways by Russia. Information resources are used to manipulate objective reality in favor of the Russian perception of events, all the while disregarding logic and the accumulation of available evidence and proof that totally offset the Russian version of events.

Russian theorists focus their IWes in the following characteristics, types, advantages, targets, and challenges:

- ◆ IWe characteristics: universality, covertness, variety of software and hardware implementation, radicalism of effects, adequate choice of time and place of employment, and, finally, cost-effectiveness
- ◆ IWe types: NLWs, color-revolutions, NGOs, high-precision weapons, electronic warfare assets, electromagnetic pulse weapons, software viruses, energy-information-psychological weapons; psychotropic-information weapons; technical means (generators, etc.) of virtual information-psychological weaponry; and information-psychological weapons integrated with fire, radio-electronic, and energy effects
- ◆ IWe advantages: can be used in secret, can cross borders with impunity, and can be used against military and civilian structures; offer freedom of access to adversary information systems, such as social media; and allow for the covert preparation of battlefields years in advance with placement of specific software in an adversary's cyber operations
- ◆ IWe targets: warfighting, economic, and social systems, along with computers; programmable apparatuses, command and control means, communication and decision-making channels, and the human intellect and mass consciousness
- ◆ IWe problems (Note: this is a Russian perspective): IWes threaten strategic stability and the violation of territorial integrity; it is hard to get UN agreement to limit IWe development; it is important to guard against the Western use of color revolutions and nongovernmental organizations to falsify history and manipulate public opinion against Russia; we must be vigilant for information sabotage

- ◆ IWe effects: physical, informational, software, or radio-electronic; special pharmacological means and the mass media; information technologies that intensify the accuracy of munitions and reconnaissance assets and offer the pervasive application of propaganda and software; energy (as components of EW, microwave, and cruise or unmanned aerial vehicles); and chemical (gases, aerosols, pharmacologic agents, etc.)

In Summary, the Russian understanding of an IWe is much broader than how the term might be understood in the West. There is much for analysts to consider as they ponder Russian access to and use of the IWe, especially as Russia will continue to search for new and innovative applications of their use. ♥

NOTES

1. The "IWe" acronym is used to distinguish the term from information war and irregular war, which are both shortened to IW and cause enough confusion without adding another IW acronym.
2. V.I. Tsybal, "The Concept of Information Warfare," presentation at a September 1995 conference in Moscow, Russia, 7, attended by the author of this article.
3. Andrei Soldatov and Irina Borogan, *The New Nobility*, Public Affairs New York, 2010, 108-109.
4. V.I. Slipchenko, *Beskontaknyye Voyny (Noncontact Wars)*, Publishing House Gran-Press, 2001, 55.
5. *Ibid.*, 82. Slipchenko wrote on new-generation warfare more than a decade before Bogdanov and Chekinov did so in 2013, to great fanfare.
6. *Ibid.*, 85-88.
7. *Ibid.*, 90-91.
8. *Ibid.*, 161.
9. *Ibid.*
10. *Ibid.*
11. Vasily Y. Dolgov and Yuriy D. Podgornykh, "Space as a Theater of Military Operations: On Possible Forms and Methods of Combat Employment of Space Command Forces and Assets," *Vozdushno-Kosmicheskaya Oborona Online*, April 10, 2013.
12. S.V. Markov, "Several Approaches to the Determination of the Essence of the Information Weapon," *Bezopasnost (Security)*, No. 1-2, 1996, 53.
13. *Ibid.*
14. *Ibid.*, 56.
15. V.N. Tsygichko, D.S. Votrin, A.V. Krutskikh, G.L. Smolyan, and D.S. Chereshekin, *The Information Weapon—A New Challenge to International Security*, Institute of Systems Analysis, Moscow, 2000, 20-21. This IWe discussion is taken from Timothy Thomas, *Cyber Silhouettes*, Foreign Military Studies Office, Fort Leavenworth, KS, 2005, 168-171.
16. *Ibid.*
17. N.P. Shekhovtsov and I.E. Kuleshov, "Information Weapons: Theory and Practice of Their Employment in Information Warfare," *Vestnik Akademii Voennykh Nauk (Journal of the Academy of Military Science)*, 2012, No. 1, 39.
18. Aleksandr V. Fedorov and Vitaliy N. Tsygichko, "Information Weapons as a New Means of Warfare," Chapter Three, of *Information Challenges to National and International Security*, PIR Center, Moscow 2001, 69-109.
19. *Ibid.*
20. *Ibid.*
21. Vladimir Slipchenko, "A New Form of Struggle: In the Coming Century, The Role of Information in Noncontact Wars Will Only Grow," *Armeyskiy Sbornik (Army Journal)*, No. 12 2002, 30-32.
22. Vitaliy Tsygichko and Vladimir Dyachenko, "Non-Lethal Weapons," *Yadernyy Kontrol (Nuclear Control)*, 18 September 2002, 58-67.
23. S. P. Nepobedimiy and V. F. Prokofyev, "The Intellectualization of Weapons and Weapons against Human Intelligence," *Voennaya Mysl' (Military Thought)*, No. 7 2003, 26.
24. *Ibid.*, 27.
25. Oscar Jonsson, *The Russian Understanding of War*, Georgetown University Press, 2019, 94, as quoted in Steve Blank, "Russian Information Warfare as Domestic Counterinsurgency," *American Foreign Policy Interests*, 34.
26. I.N. Chibisov and V.A. Vodkin, "The Information-Strike Operation," *Armeyskiy Sbornik (Army Journal)*, March 2011, 46.
27. *Ibid.*, 46-47.
28. *Ibid.*, 47.
29. *Ibid.*, 48.
30. *Ibid.*, 48-49.
31. Shekhovtsov and Kuleshov, 35.
32. *Ibid.*, 36.
33. *Ibid.*, 36-37.
34. *Ibid.*, 37.

NOTES

35. Ibid., 38.
36. Ibid., 39.
37. S. G. Chekinov and S. A. Bogdanov, “The Initial Period of War and its Influence on a Country’s Preparation for Future War,” *Voyennaya Mysl’ (Military Thought)*, No. 11 2012, 15-16.
38. Ibid., 19.
39. Ibid., 25.
40. Unattributed report, “A State Duma Committee Has Approved Amendments Relating to Information Security,” *RIA Novosti Online (RIA News Online)*, November 8, 2013.
41. S. G. Chekinov and S. A. Bogdanov, “On the Nature and Content of a New Generation War,” *Voyennaya Mysl’ (Military Thought)*, No. 10, 2013, 13-14.
42. Ibid., 20.
43. Ibid., 23.
44. Ninth International Forum “Partnership of State Authorities, Civil, Society, and the Business Community in Ensuring International Information Security,” April 20-23, 2015, Garmisch Germany, 36.
45. Ibid.
46. D. V. Zaitsev, V. I. Orlyansky, and D. Yu. Soskov, “Nonlethal Weapons Can Be Used to Prevent Armed Conflicts,” *Voennaya Mysl’ (Military Thought)*, No. 10 2015, 51.
47. Edict of the Russian Federation President, “On the Russian Federation’s National Security Strategy,” *President of Russia Website*, December 31, 2015. See sections 13, 21, 36, 43, and 53 of the document.
48. V.V. Gerasimov, “The Organization of the Defense of the Russian Federation under Conditions of the Enemy’s Employment of ‘Traditional’ and ‘Hybrid’ Methods of Conducting War,” *Vestnik Akademii Voennykh Nauk (Journal of the Academy of Military Science)*, No. 2, 2016, 20.
49. Thom Shanker and Mark Landler, “Putin Says U.S. Is Undermining Global Stability,” *The New York Times*, 11 February 2007, downloaded 9/1/2020 at <https://www.nytimes.com/2007/02/11/world/europe/11munich.html>.
50. S. G. Chekinov and S. A. Bogdanov, “The Evolution of the Essence and Content of the Notion of ‘War’ in the 21st Century,” *Voyennaya Mysl’ (Military Thought)*, No. 1 2017, 43.
51. Ibid., 40.
52. Ibid., 37.
53. Ibid., 32.
54. V. F. Lata, V. A. Annenkov, and V. F. Moiseev, “Information Confrontation: A System of Terms and Definitions,” *Vestnik Akademii Voennykh Nauk (Journal of the Academy of Military Science)*, No. 2 2019, 128-129.
55. Ibid., 130.
56. Ibid., 136.
57. Ibid., 136-137.
58. See Julia Davis, “Russia to Iran: Don’t Admit Guilt—Blame the U.S. Instead,” <https://www.thedailybeast.com/russia-to-iran-dont-admit-guilt-blame-the-us-instead>, accessed January 11, 2020.
59. A. A. Kokoshin, “Prospects for the Development of the Military Technosphere and the Future of Warfare and Noncombat Employment of Military Force,” *Vestnik Akademii Voennykh Nauk (Journal of the Academy of Military Science)*, No. 2 2019, 26.
60. Ibid., 27.
61. Ibid., 28.
62. Ibid., 29.

Affidavit
and
curriculum vitae
of
Ted Gunderson

Retyped by Cliff Huylebroeck on December 14, 2013.

www.gangstalkingwiki.com

TED L. GUNDERSON & ASSOCIATES

6230-A Wilshire Blvd., Suite 6
Los Angeles, California 90048
Phone: (337) 344-8876

I, Ted L. Gunderson, hereby swear under the pains and penalties of jury that the following statements are true and correct:

1. My name is Ted L. Gunderson. I am the owner and operator of Ted L. Gunderson & Associates, an international security and consulting firm based out of Santa Monica, California. I am currently a licensed private investigator in the state of California. I have performed private investigation and security work for numerous individuals, companies, and governments worldwide since founding my firm in 1979. I have worked for, amongst others, F. Lee Bailey, Esq., The California Narcotics Authority by appointment of Governor Jerry Brown, The 1984 Los Angeles Olympic Committee, and The 1979 Pan American Games in San Juan, Puerto Rico by appointment of then U.S. Attorney General Griffin Bell.
2. Previous to my work as a private investigator I spent nearly three decades in the F.B.I. Between 1951 and 1960 I was an F.B.I. Special Agent. In 1960 I was promoted as a supervisor at F.B.I. Headquarters in Washington, D.C., where I was in charge of Organized Crime and Racketeering investigations covering 26 F.B.I. Field Offices nationwide. Following the assassination of President John F. Kennedy, I was re-assigned to Special Inquiry White House Matters at F.B.I. Headquarters. In 1965 I was promoted again to Assistant Special Agent-In-Charge of Internal Security and Anti-Terrorism of the F.B.I. New Haven, Connecticut Field Office. In 1970 I was promoted to Assistant Special Agent-In-Charge of the F.B.I. Philadelphia, Pennsylvania Field Office. On July 12, 1972 I successfully negotiated with two terrorist hijackers of National Airlines Flight 496 for the release of 119 passengers at Philadelphia International Airport. In 1973 I was promoted to Chief Inspector at F.B.I. Headquarters. I also served

as Special Agent-In-Charge of the F.B.I. Memphis and Dallas Field Offices. I retired from the F.B.I. as Senior Special Agent-In-Charge of the Los Angeles Field Office of the F.B.I. with over 700 employees and a budget of over 22 million dollars in 1979.

3. I have read the Complaint in the current action of Mr. Keith Labella against F.B.I. and D.O.J. It is my professional opinion, based on information, knowledge and belief that the information sought by Mr. Labella in this F.O.I.A. suit regarding “gang stalking”, “gang stalking groups” and “gang stalking methods” reasonably describes an ongoing, active, covert nationwide program that is in effect today, and, based on my investigations and experience, has been operational since at least the early 1980’s. Since the 1980’s gang stalking has increased in scope, intensity and sophistication by adapting to new communications and surveillance technology. These programs are using the codenames Echelon Program, Carnivore System, and Tempest Systems. The Echelon Program is administered by the N.S.A. out of Fort Meade, Maryland, and monitors all email and phone calls in the world. Carnivore System is administered by the N.S.A. out of Fort Meade, Maryland, and can download any computer system without being traced or otherwise known to the owner. Tempest Systems can decipher what is on any computer screen up to a quarter of a mile away. These programs are negatively impacting thousands of Americans and severely abusing their civil rights on a daily basis.

4. Based on my investigative work, which includes intelligence from sources such as active and former members of the Intelligence Services (including the F.B.I., the C.I.A., the N.S.A. and Military Intelligence), information from informants active in criminal enterprises, and, victim testimonies, I have come to the conclusion that thousands of victims have been targeted by an illegal government rogue criminal enterprise that is active 24 hours a day within the U.S. This conspiracy is far too active to be controlled or operated by private enterprise whose goals are achieving financial gain. These operations require extensive financing with no return on the investment. This program’s operations are financed by illegal black operations, i.e., narcotics, prostitution, child

kidnapping (children sell at covert auctions for up to \$50,000 per child), human trafficking, gambling and other rackets.

5. I have documentation and know that throughout the U.S., operating 24 hours-a-day and 7 days-a-week, there is a Central Command, located within the U.S., with multiple satellite offices, whose administrators can instantly initiate surveillance, phone taps and harassment against any individual in the country. They have the technology, financing and manpower to dispense illegal surveillance and harassment against anyone at any time, day or night. I have files on numerous cases of active, programmatic, illegal government harassment currently being conducted against thousands of Americans. This makes the F.B.I.'s former COINTELPRO program, which I worked on, including in a supervisory capacity, look like a Sunday school program by comparison.
6. I firmly believe that most individuals working in the F.B.I., other intelligence agencies, and the government overall are honest, law-abiding public servants. However, a sophisticated network of rogue operatives has secretly infiltrated the FBI, other intelligence agencies including the C.I.A., and other key government positions. This rogue element seeks personal power and wealth and considers themselves above the law and the Constitution. They are carrying out the aforementioned surveillance and harassment activities in conjunction with organized crime, the cult movement in America including Satanic cults, other commercial and political interests, and even misguided civic organizations and neighborhood groups. This illegal surveillance and harassment program is being called gang stalking and organized stalking by the victims targeted by it. The victims are targeted for a variety of reasons including government and corporate whistleblowers, parties to financial and employment disputes, parties to marital disputes (usually divorced women), and even jilted paramours. Journalists covering controversial issues, and, even attorneys and private investigators representing unpopular clients or interests, have been targeted by this program.
7. Individuals targeted by this program have been subjected to illegal and unconstitutional phone taps, illegal re-routing of business and

private phone calls for purposes of harassment, illegal audio “bugging”, surreptitious entry into home, office, and vehicle, visual surveillance in the home conducted by illegal placement of miniature remote, wireless cameras (often accessible via internet), illegal internet spyware, illegal GPS tracking (often through their own mobile phones), regular fixed and mobile surveillance, mail misdirection, mail theft and tampering, financial and employment sabotage, slander campaigns and community ostracizing, internet disinformation and smear campaigns, poisoning, assaults and murder, illegal set-ups on drug charges and other felony charges, amongst many other civil rights abuses.

8. In addition to high-ranking members of the F.B.I., other intelligence services, and the government overall, wealthy, powerful members of criminal syndicates, multi-millionaires and the corporate elite are using the government gang stalking program to harass enemies. They can get a targeted individual harassed for the rest of that individual’s life (individual cases of gang stalking lasting for over a decade are common). The higher status members of the gang stalking conspiracy initiate the gang stalking and coordinate logistics and funding. Lower echelon government rogue operatives, lower ranking members of the military (in violation of Posse Comitatus), petty criminals and street thugs perform the actual grunt work of daily monitoring and harassment of individuals targeted by the program.
9. Based on my professional experience, extensive intelligence information and belief, it is my professional opinion that the F.B.I. is involved in and has investigative files on the subject of gang stalking, related gang stalking methods, and gang stalking groups in the F.B.I.’s vast intelligence files, that are responsive to Mr. Labella’s F.O.I.A. Complaint. Furthermore, I have personally referred numerous victims of gang stalking to the appropriate agents at the F.B.I. for investigation of their cases. I have also furnished the F.B.I. with documentation of an active international child kidnapping ring probably operated by rogue C.I.A. agents. The F.B.I. has ignored my requests to investigate even though it is their responsibility to investigate kidnappings. I have a contact in Germany who advises me that the C.I.A. has set up secret operations on U.S. military bases for the kidnapping, sale and

trafficking of children worldwide. The F.B.I. may be using a unique codename and nomenclature for the gang stalking phenomenon in its records. However, this is a semantic difference, and, in no way changes my professional opinion that the F.B.I. has investigative files on the nationwide phenomenon of gang stalking described in reasonable and specific detail in Mr. Labella's F.O.I.A Complaint. These F.B.I. files contain information responsive to Mr. Labella's F.O.I.A Complaint regarding the subject of gang stalking. The F.B.I. and other intelligence agencies are administering and covering up the rogue, covert, government criminal enterprise of gang stalking. The gang stalking phenomenon appears in the records of both the F.B.I. and the N.S.A. in their records pertaining to the Echelon Program, Carnivore System, and Tempest Systems. In addition, the gang stalking phenomenon appears in the records of both the F.B.I. and the N.S.A. in their records pertaining to information collected by Narus systems. Narus is a wholly owned subsidiary of defense contractor Boeing that produces sophisticated, mass surveillance computer systems currently being used by both the F.B.I. and the N.S.A.

Dated this 26 day of April 2011.

Los Angeles, California

Ted L. Gunderson

TED L. GUNDERSON & ASSOCIATES

6230-A Wilshire Blvd., Suite 6
Los Angeles, California 90048
Phone: (337) 344-8876

I, Ted L. Gunderson, hereby swear under the pains and penalties of jury that the following statements are true and correct:

1. My name is Ted L. Gunderson. I am the owner and operator of Ted L. Gunderson & Associates, an international security and consulting firm based out of Santa Monica, California. I am currently a licensed private investigator in the state of California. I have performed private investigation and security work for numerous individuals, companies, and governments worldwide since founding my firm in 1979. I have worked for, amongst others, F. Lee Bailey, Esq., The California Narcotics Authority by appointment of Governor Jerry Brown, The 1984 Los Angeles Olympic Committee, and The 1979 Pan American Games in San Juan, Puerto Rico by appointment of then U.S. Attorney General Griffin Bell.
2. Previous to my work as a private investigator I spent nearly three decades in the F.B.I. Between 1951 and 1960 I was an F.B.I. Special Agent. In 1960 I was promoted as a supervisor at F.B.I. Headquarters in Washington, D.C., where I was in charge of Organized Crime and Racketeering investigations covering 26 F.B.I. Field Offices nationwide. Following the assassination of President John F. Kennedy, I was re-assigned to Special Inquiry White House Matters at F.B.I. Headquarters. In 1965 I was promoted again to Assistant Special Agent-In-Charge of Internal Security and Anti-Terrorism of the F.B.I. New Haven, Connecticut Field Office. In 1970 I was promoted to Assistant Special Agent-In-Charge of the F.B.I. Philadelphia, Pennsylvania Field Office. On July 12, 1972 I successfully negotiated with two terrorist hijackers of National Airlines Flight 496 for the release of 119 passengers at Philadelphia International Airport. In 1973 I was promoted to Chief Inspector at F.B.I. Headquarters. I also served

as Special Agent-In-Charge of the F.B.I. Memphis and Dallas Field Offices. I retired from the F.B.I. as Senior Special Agent-In-Charge of the Los Angeles Field Office of the F.B.I. with over 700 employees and a budget of over 22 million dollars in 1979.

3. I have read the Complaint in the current action of Mr. Keith Labella against F.B.I. and D.O.J. It is my professional opinion, based on information, knowledge and belief that the information sought by Mr. Labella in this F.O.I.A. suit regarding “gang stalking”, “gang stalking groups” and “gang stalking methods” reasonably describes an ongoing, active, covert nationwide program that is in effect today, and, based on my investigations and experience, has been operational since at least the early 1980’s. Since the 1980’s gang stalking has increased in scope, intensity and sophistication by adapting to new communications and surveillance technology. These programs are using the codenames Echelon Program, Carnivore System, and Tempest Systems. The Echelon Program is administered by the N.S.A. out of Fort Meade, Maryland, and monitors all email and phone calls in the world. Carnivore System is administered by the N.S.A. out of Fort Meade, Maryland, and can download any computer system without being traced or otherwise known to the owner. Tempest Systems can decipher what is on any computer screen up to a quarter of a mile away. These programs are negatively impacting thousands of Americans and severely abusing their civil rights on a daily basis.
4. Based on my investigative work, which includes intelligence from sources such as active and former members of the Intelligence Services (including the F.B.I., the C.I.A., the N.S.A. and Military Intelligence), information from informants active in criminal enterprises, and, victim testimonies, I have come to the conclusion that thousands of victims have been targeted by an illegal government rogue criminal enterprise that is active 24 hours a day within the U.S. This conspiracy is far too active to be controlled or operated by private enterprise whose goals are achieving financial gain. These operations require extensive financing with no return on the investment. This program’s operations are financed by illegal black operations, i.e., narcotics, prostitution, child

kidnapping (children sell at covert auctions for up to \$50,000 per child), human trafficking, gambling and other rackets.

5. I have documentation and know that throughout the U.S., operating 24 hours-a-day and 7 days-a-week, there is a Central Command, located within the U.S., with multiple satellite offices, whose administrators can instantly initiate surveillance, phone taps and harassment against any individual in the country. They have the technology, financing and manpower to dispense illegal surveillance and harassment against anyone at any time, day or night. I have files on numerous cases of active, programmatic, illegal government harassment currently being conducted against thousands of Americans. This makes the F.B.I.'s former COINTELPRO program, which I worked on, including in a supervisory capacity, look like a Sunday school program by comparison.
6. I firmly believe that most individuals working in the F.B.I., other intelligence agencies, and the government overall are honest, law-abiding public servants. However, a sophisticated network of rogue operatives has secretly infiltrated the F.B.I., other intelligence agencies including the C.I.A., and other key government positions. This rogue element seeks personal power and wealth and considers themselves above the law and the Constitution. They are carrying out the aforementioned surveillance and harassment activities in conjunction with organized crime, the cult movement in America including Satanic cults, other commercial and political interests, and even misguided civic organizations and neighborhood groups. This illegal surveillance and harassment program is being called gang stalking and organized stalking by the victims targeted by it. The victims are targeted for a variety of reasons including government and corporate whistleblowers, parties to financial and employment disputes, parties to marital disputes (usually divorced women), and even jilted paramours. Journalists covering controversial issues, and, even attorneys and private investigators representing unpopular clients or interests, have been targeted by this program.
7. Individuals targeted by this program have been subjected to illegal and unconstitutional phone taps, illegal re-routing of business and

private phone calls for purposes of harassment, illegal audio “bugging”, surreptitious entry into home, office, and vehicle, visual surveillance in the home conducted by illegal placement of miniature remote, wireless cameras (often accessible via internet), illegal internet spyware, illegal GPS tracking (often through their own mobile phones), regular fixed and mobile surveillance, mail misdirection, mail theft and tampering, financial and employment sabotage, slander campaigns and community ostracizing , internet disinformation and smear campaigns, poisoning, assaults and murder, illegal set-ups on drug charges and other felony charges, amongst many other civil rights abuses.

8. In addition to high-ranking members of the F.B.I., other intelligence services, and the government overall, wealthy, powerful members of criminal syndicates, multi-millionaires and the corporate elite are using the government gang stalking program to harass enemies. They can get a targeted individual harassed for the rest of that individual’s life (individual cases of gang stalking lasting for over a decade are common). The higher status members of the gang stalking conspiracy initiate the gang stalking and coordinate logistics and funding. Lower echelon government rogue operatives, lower ranking members of the military (in violation of Posse Comitatus), petty criminals and street thugs perform the actual grunt work of daily monitoring and harassment of individuals targeted by the program.
9. Based on my professional experience, extensive intelligence information and belief, it is my professional opinion that the F.B.I. is involved in and has investigative files on the subject of gang stalking, related gang stalking methods, and gang stalking groups in the F.B.I.’s vast intelligence files, that are responsive to Mr. Labella’s F.O.I.A. Complaint. Furthermore, I have personally referred numerous victims of gang stalking to the appropriate agents at the F.B.I. for investigation of their cases. I have also furnished the F.B.I. with documentation of an active, international child kidnapping ring probably operated by rogue C.I.A. agents. The F.B.I. has ignored my requests to investigate even though it is their responsibility to investigate kidnappings. I have a contact in Germany who advises me that the C.I.A. has set up secret operations on U.S. military bases for the kidnapping, sale and

trafficking of children worldwide. The F.B.I. may be using a unique codename and nomenclature for the gang stalking phenomenon in its records. However, this is a semantic difference, and, in no way changes my professional opinion that the F.B.I. has investigative files on the nationwide phenomenon of gang stalking described in reasonable and specific detail in Mr. Labella's F.O.I.A. Complaint. These F.B.I. files contain information responsive to Mr. Labella's F.O.I.A. Complaint regarding the subject of gang stalking. The F.B.I. and other intelligence agencies are administering and covering up the rogue, covert, government criminal enterprise of gang stalking. The gang stalking phenomenon appears in the records of both the F.B.I. and the N.S.A. in their records pertaining to the Echelon Program, Carnivore System, and Tempest Systems. In addition, the gang stalking phenomenon appears in the records of both the F.B.I. and the N.S.A. in their records pertaining to information collected by Narus systems. Narus is a wholly owned subsidiary of defense contractor Boeing that produces sophisticated, mass surveillance computer systems currently being used by both the F.B.I. and the N.S.A.

Dated this 26 day of April 2011.

Los Angeles, California

Ted L. Gunderson
Ted L. Gunderson

NOTARY

CALIFORNIA ALL-PURPOSE ACKNOWLEDGMENT

State of California

County of Los Angeles

On 4-29-2011 before me, Robert R.S. Propp
Date Here Insert Name and Title of the Officer

personally appeared Ted L Gunderson
Name(s) of Signer(s)



who proved to me on the basis of satisfactory evidence to be the person(s) whose name(s) is/are subscribed to the within instrument and acknowledged to me that he/she/they executed the same in his/her/their authorized capacity(ies), and that by his/her/their signature(s) on the instrument the person(s), or the entity upon behalf of which the person(s) acted, executed the instrument.

I certify under PENALTY OF PERJURY under the laws of the State of California that the foregoing paragraph is true and correct.

WITNESS my hand and official seal.

Signature [Handwritten Signature]
Signature of Notary Public

Place Notary Seal Above

OPTIONAL

Though the information below is not required by law, it may prove valuable to persons relying on the document and could prevent fraudulent removal and reattachment of this form to another document.

Description of Attached Document

Title or Type of Document: Statement of Ted L Gunderson & Associates

Document Date: 4-26-2011 Number of Pages: (5)

Signer(s) Other Than Named Above: _____

Capacity(ies) Claimed by Signer(s)

Signer's Name: Ted L Gunderson

- Individual
- Corporate Officer — Title(s): _____
- Partner — Limited General
- Attorney in Fact
- Trustee
- Guardian or Conservator
- Other: _____



Signer Is Representing: _____

Signer's Name: _____

- Individual
- Corporate Officer — Title(s): _____
- Partner — Limited General
- Attorney in Fact
- Trustee
- Guardian or Conservator
- Other: _____



Signer Is Representing: _____

TED L. GUNDERSON
FBI Bureau Chief,
Senior Special Agent In Charge, (Ret.)
Head of the Los Angeles Office of the
Federal Bureau of Investigation
6230 A Wilshire Blvd.
Los Angeles, CA 90048
Direct Line: (337)344-8876
California Investigation License Number: 12878

PROFESSIONAL EXPERIENCE

- 1979 – Present Ted L. Gunderson & Associates.
Founder, owner and operator of this international security consulting and investigation firm in 1979. Investigator for F. Lee Bailey Esq., Mr. Bailey describes Ted Gunderson as a person “whose investigative skills are unsurpassed by anyone I know or have known”. At the time of retirement from the Federal Bureau of Investigations, Ted had 700 personnel under his command and he operated an annual budget of Twenty Two Million dollars (USD 22,000,000.00).
- Ted is a renowned lecturer, published author and researcher. National Television and radio appearances include “The Geraldo Show”, “48 Hours Mysteries”, “Unsolved Mysteries” and “Larry King Live”. He has been regularly featured on Discovery Channel and Lifetime.
- 1984 Los Angeles Olympics Committee Consultant.
- 1981 – 1982 California Narcotics Authority – Consultant appointed by Governor Jerry Brown.
- 1979 Pan American Games, San Juan, Puerto Rico – Security Coordinator
Special Appointee of United States Attorney General Griffin B. Bell.
- 1951 – 1979 Federal Bureau of Investigations
- 1977 – 79 Senior Special Agent-In-Charge, Los Angeles, California
1973 – 77 Special Agent-In-Charge, Memphis, Tennessee and Dallas, Texas
1973 Chief Inspector
1965 – 73 Assistant Special Agent-In-Charge, New Haven, Connecticut and
Philadelphia, Pennsylvania
1960 – 65 Special Agent Supervisors – Federal Bureau of Investigations
Headquarters, Washington, D.C.
1951 – 60 Special Agent

PUBLICATIONS 1989 “How To Locate Anyone Anywhere Without Leaving Home” –
E.P. Dutton

EDUCATION 1950 Bachelor of Science – University of Nebraska

AWARDS 1979 Distinguished Alumnus Award in Recognition of Distinguished and
Devoted Service to His Country – University of Nebraska
1977 Alumni Highest Effort Award in the Field of law Enforcement, Sigma
Alpha Epsilon Social Fraternity
1977 Law enforcement Officer of the Year – AFL-CIO Metal Trades
Counsel, Los Angeles, California

An Open Secret:

The Growing Problem of Cyber Torture via Coordinated Stalking

Advocacy for Humankind (AFH) is a California, Bay Area organization founded in June of 2019.

We seek to eradicate the growing crimes of cyber torture via coordinated stalking through public awareness, education, and advocacy for victims. Working with our sister Bay Area organization, the Bay Area Support Group (BASG), we are intimately acquainted with the environments and structures that underpin this open secret in our California communities. Our support group currently has over 100 members.

www.advocacyforhumankind.com

www.bayareasupport.org

We are encouraged and appreciative of the Special Rapporteur's efforts to raise international awareness and address these human rights violations. Our hope is that this statement will provide the rapporteur with the necessary information to assist in advancing his efforts.

RELEVANT PSYCHOSOCIAL DYNAMICS CONDUCTIVE TO TORTURE AND ILL-TREATMENT

Coordinated stalking victims experience psychological attacks in full view of their communities, workplaces, and families. Their victimization is an open secret in their environments, making it easy for authorities, civil servants, and communities at large to dismiss and/or misdiagnose them. Highlighted below are some of the key components:

1. Reasons differ. The reason may never be known to the victim, though many are whistleblowers, employees who reported sexual harassment, or have had a fallout with a spouse or other known associate. Example below:
<https://fortune.com/2020/06/15/ex-ebay-executives-charged-with-stalking-campaign/>
2. Preceding the victims' awareness, a combination of surveillance and character assassination creates the foundation for a total life destruction scenario, whereby the victim is pushed out of jobs, neighborhoods, and social circles.
3. Surveillance is highly advanced and pervasive and occurs in and out of the home. Smart devices/apps are used by the cadre of abusers, allowing for coordinated timing in carrying out the various forms of abuse.
4. Multiple abusers participate who are strangers to the victim and have no personal reason to be involved. Public mobbing is prevalent, and victims are forced to endure multiple encounters with every foray into the public.
5. Recruitment of neighbors, family, and friends to participate in the persecution of the victim is executed when possible.
6. Contact is constant. Victims report a 24/7/365 pattern of various forms of stalking, intimidation, vandalism, and harassment, creating a non-stop torturous environment.
7. Workplace mobbing is reported in most cases, resulting in inability to stay employed and resulting in homelessness.

8. Traditional physical violence is not typical. Directed energy devices such as those used on the China and Cuba diplomats are heavily reported.
9. Crimes are carried out by highly organized networks of participants. Many are paid by contractors, PI firms, security firms.
10. Law enforcement regularly dismisses victims reporting these crimes. Protective orders do not work for coordinated stalking. Even if a perpetrator is identified, typically there is no way to know or prove if they have shown up more than once.
12. Investigations are seldom conducted.
13. Victims can be re-victimized by being placed on psychiatric holds when reporting crimes to authorities.
14. Even if victim moves out of state (many do), stalking will continue, crossing state lines and breaking federal laws.
15. Victims find it difficult to convince anybody of what they are experiencing and consequently find themselves isolated and lacking meaningful support.
16. Severe psychological and physical effects are routinely reported. Few resources exist to support victims.

RECOMMENDED NORMATIVE, INSTITUTIONAL AND POLICY MEASURES OF PREVENTION AND MITIGATION.

The existing federal and California state laws pertaining to stalking provide some protections for victims of cyber torture via coordinated stalking. The advancement of technology and the monetization of these crimes by contracted security firms, private investigation agencies and criminal elements necessitate additional protections. The following are suggested to strengthen current laws and policy:

1. Prohibit for-profit contract and coordinated stalking and punishable by law and compensation:
 - a. By firms such as private investigators and security providers. Revoke client/attorney privilege in such instances
 - b. By individuals hired as agents of firms earning pay to conduct these illegal operations
 - c. By landowners, property managers and landlords recruited and paid to be complicit and conduct harassment in apartment buildings and rentals, while not offering redress to tenants of documented issues
2. Make liable businesses that contract to be complicit in these crimes as well as any employees acting as their agents while committing such crimes.
3. Make the use of phone/device applications for tracking victims as a part of coordinated efforts to stalk, illegally surveil and harass individuals punishable by law and compensation.
4. Create task force to educate law enforcement at all levels across the nations about these crimes and require that they provide a safe environment for victims when they seek assistance.
5. Require federal and local law enforcement to investigate reported cases of cyber torture via coordinated stalking.

AFH Data on Self-Reported Victims of Coordinated Stalking in California

The following data was collected via surveys conducted by the Bay Area Support Group (BASG) and statewide counts collected by Surveillance Harassment Survivors Alliance (SHSA). The goal of collecting this information is to provide a data driven picture of coordinated stalking crimes in the state of California. Much like sexual assault, coordinated stalking crimes are grossly under reported. What follows is a small sample size of self-reported victims. We are working to apply statistical methodology to estimate the true population size of victims in the state. Outreach efforts by BASG, Surveillance Harassment Survivors Alliance (SHASA) and other organizations addressing this issue across the country are ongoing to provide support to victims that will allow them to come forward and be counted.

There were 417 respondents to the CA statewide survey by SHSA. Stats include the cbsa counts, populations, & percentage of reported victims accounted for by each core-based statistical areas (cbsa). The census bureau describes a cbsa as a "U.S. geographic area defined by the Office of Management and Budget that consists of one or more counties anchored by an urban center of at least 10,000 people plus adjacent counties that are socioeconomically tied to the urban center by commuting". 15 observations did not specify location:

cbsa	#	pop	%
Bakersfield, CA	8	851,710	1.92%
Chico, CA	1	220,266	0.24%
Fresno, CA	11	942,904	2.64%
Los Angeles-Long Beach-Santa Ana, CA	232	12,944,801	55.64%
Merced, CA	3	259,898	0.72%
Modesto, CA	1	518,522	0.24%
Napa, CA	4	138,088	0.96%
Oxnard-Thousand Oaks-Ventura, CA	3	831,771	0.72%
Redding, CA	2	177,774	0.48%
Riverside-San Bernardino-Ontario, CA	37	4,304,997	8.87%
Sacramento--Arden-Arcade--Roseville, CA	36	2,158,918	8.63%
Salinas, CA	3	421,898	0.72%
San Diego-Carlsbad-San Marcos, CA	42	3,140,069	10.07%
San Francisco-San Mateo-Redwood City, CA	70	4,335,391	16.79%
San Jose-Sunnyvale-Santa Clara, CA	17	1,865,450	4.08%
San Luis Obispo-Paso Robles, CA	2	271,969	0.48%
Santa Barbara-Santa Maria-Goleta, CA	1	426,878	0.24%
Santa Cruz-Watsonville, CA	6	851,710	1.44%
Santa Rosa-Petaluma, CA	6	220,266	1.44%
Stockton, CA	9	942,904	2.16%
Vallejo-Fairfield, CA	6	12,944,801	1.44%
Visalia-Porterville, CA	2	259,898	0.48%
Yuba City, CA	1	518,522	0.24%

Data demonstrates a correlation between cbsa population size and the frequency of self-reported victims.

This section provides a detailed look at the experiences of 90 self-reported victims of coordinated stalking in the Bay Area. This data was collected from surveys solicited by the Bay Area Support Group (BASG). Criteria for inclusion in the report was that a victim began experiencing coordinated stalking protocols while a resident of California. Surveys were requested in a long hand format and responses were then synthesized into simple data categories for analysis. It is important to note that synthesizing data from a written format will incur some under reporting of experiences. Advocacy for Humankind will be working to increase sample size, and detail of data collection to provide a more robust reporting mechanism.

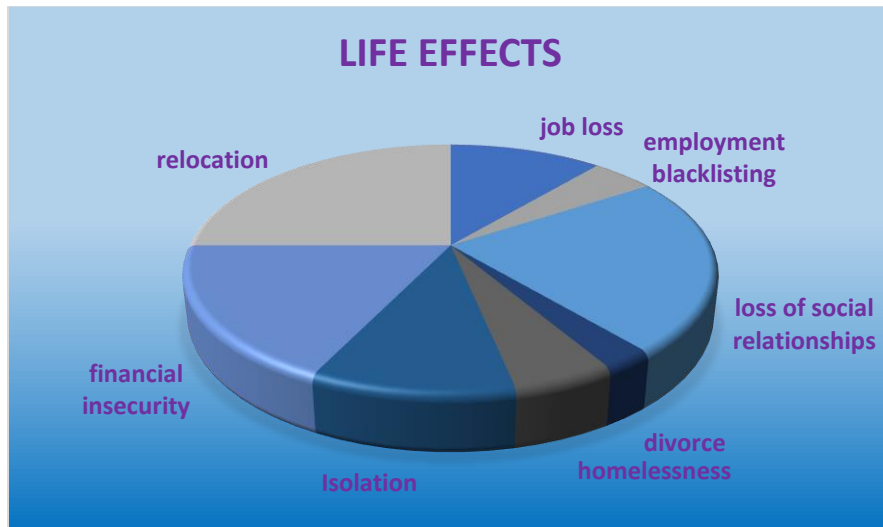

Life Effects Data

job loss	17	19%
employment blacklisting	7	8%
loss of family/friend/dating relationships	35	39%
divorce	4	4%
homelessness	8	9%
Isolation	16	18%
financial insecurity	27	30%
relocation	38	42%

Coordinated Stalking Experiences

followed/surveilled/DED assaults	76	84%
community base stalking	38	42%
vehicular stalked/surveilled	33	37%
workplace mobbing	43	48%
noise campaigns	23	26%
Home and car break-ins	20	22%
smear campaign/slander/character assassination	50	56%
family also experiencing coordinated stalking	14	16%

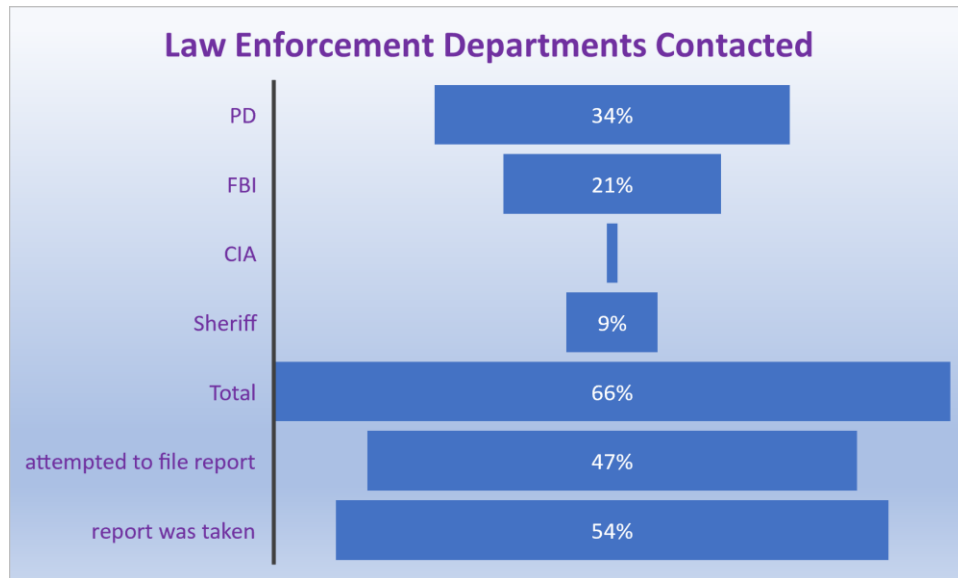

Victims reported contacting federal or state law enforcement in 66% of the surveys. Of those contacts only 47% of the time did the victims feel safe and supported enough to request a formal report from the department they contacted. In those instances where an official report was requested only 54% of the time were victims successful in filing and obtaining copies of an official report.

GLOSSARY OF TERMS AND RELEVANT TERMINOLOGY

Community based stalking is the use of community websites, apps and organizations to illegally surveil, follow and harass victims in those communities. Victims are not given due process, notification, or reason for the abuses. Citizen participants are often manipulated into carrying out these illegal acts via slander campaigns. In some cases, compensation for these acts solidifies motivation

Coordinated Stalking: occurs when multiple people (both within and outside of the community) conspire to willfully, maliciously, and repeatedly follow, surveil and harass an individual with the intent of placing that person in reasonable fear for his or her safety, or that of his or her immediate family. Perpetrators of these crimes may or may not be known to the victim or necessarily have cohabitated with the victim in the past or present. Also referred to as stalking by proxy.

Cyber Torture: Cyber-technology used to inflict, or contribute to, severe mental suffering while avoiding the conduit of the physical body, most notably through intimidation, harassment, surveillance, public shaming, and defamation, as well as appropriation, deletion, or manipulation of information.

Directed energy devices (DED): are ranged weapons that damage the subject with highly focused energy. Includes laser, microwaves, and particle beams.

Noise campaign: An orchestrated effort to produce stress in a victim through prolonged exposure to significant noise levels. Slander campaign. Also known as smear tactic or simply a smear. An effort to damage or call into question a person's reputation by propounding negative propaganda. Can be applied to individuals or groups.

Workplace bullying/mobbing: With participation of colleagues and management, a relentless campaign of psychological abuse (gossip, criticism, false reporting to management, shunning, gratuitous lack of cooperation, generally nasty behavior). Daily, ongoing ridicule and humiliation are employed, and eventually the victim is removed or forced out of the workplace. Workplace mobbing can result in the subject quitting their job or getting fired.

TRAPPED IN A BLACK BOX:

Growing Terrorism Watchlisting in Everyday Policing

Issued by:



Prepared by:

Civil Liberties and National Security Clinic, Yale Law School

April 2016

TABLE OF CONTENTS

Executive Summary	1
Key Findings.....	1
I. Background	3
II. New Data	5
III. Nominations	12
A. Historical Developments	13
B. Current Nomination Procedures and Criteria.....	16
IV. Encounters with Local Law Enforcement	21
A. The Encounter Process	22
B. Description of Handling Codes	24
V. Silent Hits	28
A. Criteria for Silent Hit Nominations.....	28
B. Expanding Use	29
C. Fewer Procedural Protections.....	31
VI. Redress	32
Conclusion	33
Acknowledgments	34

The cover was designed by Alice A. Wang and uses an image modified from a video by allDGoodNamesRtaken (https://www.youtube.com/watch?v=jVV5E5aK_r8), available under a Creative Commons Attribution license.

EXECUTIVE SUMMARY

In the last fifteen years, the U.S. government has drastically expanded a consolidated watchlisting system that includes hundreds of thousands of individuals based on secret evidence. Some parts of that system have drawn significant attention, including the No Fly List—composed of individuals who are barred from flying to, from, or over U.S. airspace—and, to a lesser extent, the Selectee List—composed of individuals who are subjected to additional screening and questioning every time they seek to board an airplane. Yet a key component of the watchlisting system has received far less scrutiny: the Known or Suspected Terrorist (KST) File, which is maintained by the FBI and is accessible to federal, state, and local law enforcement entities nationwide through the National Crime Information Center (NCIC).

The KST File is a successor to what was known until 2009 as the Violent Gangs and Terrorist Organizations File (VGTOF). Whereas VGTOF contained fewer than 10,000 terrorism-related entries in 2003, KST contains hundreds of thousands of entries today. To be sure, law enforcement agencies have a legitimate interest in coordinating efforts to locate people for whom arrest warrants are outstanding. Today, though, KST is part of a vast system of domestic surveillance of people whom law enforcement labels suspect based on vague and loose criteria, with serious constitutional and privacy implications for those who are included in the File. Such individuals may be stigmatized as potential terrorists and are vulnerable to increased law enforcement scrutiny, often without knowing that they are on a secret watchlist, and without a meaningful way to confirm or contest their inclusion.

The ACLU obtained information from the FBI about its VGTOF/KST File through a Freedom of Information Act (FOIA) request and subsequent lawsuit. Although much about the current size and operation of KST remains secret from the public, the more than 13,000 pages we now have, covering a five-year period from December 2003 to December 2008, offer key insights into the workings of this sprawling government database. Further information we analyze in this report came from another FOIA suit brought by the Electronic Privacy Information Center, inspector general reports, and the government's Watchlisting Guidance leaked to the media in August 2014.

This report presents an analysis of the most important findings from these documents and other resources, which raise serious concerns about the fairness, accuracy, and effectiveness of the KST File.

Key Findings

The number of individuals tracked by the VGTOF/KST File has increased exponentially. From just over 13,000 entries in 2003, VGTOF ballooned to 272,198 entries in 2008, and KST is

likely far larger today. Such dramatic growth does not reflect a commensurate increase in terrorist activity inside the United States during that time. In fact, terrorist activity in the United States since 2001 has been historically low and declining. Rather, the watchlist's growth appears to result from a combination of the FBI's decision to loosen the requirements for inclusion in the watchlist and the FBI's shift in focus from federal law enforcement to domestic intelligence gathering.

The documents raise serious questions about the accuracy of many of the records in the VGTOF/KST File. The FOIA documents indicate that the FBI long lacked sufficient safeguards for new entries to the File, increasing the risk that innocent individuals would be placed in it and retained there indefinitely. Although the process has become more centralized over time, the current system lacks adequate substantive oversight for existing entries and utilizes a low "reasonable suspicion" evidentiary standard that is subject to numerous exceptions.

The primary purpose of the VGTOF/KST File is not law enforcement, but the surveillance and tracking of individuals for indefinite periods. It would be legitimate for law enforcement to create a list of individuals for whom arrest warrants have been issued, but such individuals constitute a minuscule percentage of the overall number of records in the File. Police encounters with others in the File almost never result in arrest and are not intended to do so. Rather, the encountering officer is instructed to relay information about the watchlisted individual to the FBI without revealing to the individual that she has been watchlisted or that such information is being gathered or communicated. That information can include anything that the officer might glean during the encounter, such as vehicle information, travel plans and history, and the identities and other details of family members and companions.

The FBI and other government agencies use "silent hits" to track encounters with a watchlisted person without alerting frontline law enforcement officers. During such encounters, the FBI receives an automatic notification of the encounter, while the frontline officer's search of the individual's name and biometric information yields no indication of the individual's watchlisted status. FBI documents from 2009 showed that use of the "silent hit" system became increasingly widespread, and such routine use underscores that the KST File is principally a domestic intelligence-gathering tool, not a means of locating and apprehending criminals.

Redress for individuals who are erroneously placed in the KST File is essentially nonexistent. The FBI's longstanding policy is neither to confirm nor deny that an individual is on a terrorism watchlist. Unlike those on the No Fly List or the Selectee List, whose status on a watchlist becomes clear when they are prevented from boarding a flight or are continually subjected to additional screening, those in the KST File are unlikely to receive such de facto notice. Law enforcement officers who have access to the watchlist may learn that the government considers a person a terrorism suspect during traffic stops or in other contexts, but in

order not to alert individuals to the possibility of a pending investigation, the officers are instructed not to reveal to the individuals that they are on a terrorist watchlist. Even if, as often happens, individuals come to suspect that they have been placed in the KST File, the FBI has not instituted a process through which they can contest that placement and clear their names. The KST File is essentially a black box—an opaque and expanding accumulation of names.

* * *

Disseminating potentially erroneous, inaccurate, or outdated information on an ever-expanding population of watchlisted individuals to hundreds of thousands of law enforcement officers nationwide stigmatizes those individuals as potential terrorists and exposes them to a heightened risk of unwarranted scrutiny or investigation by police. Additionally, leaked documents show that American Muslim communities are disproportionately watchlisted, further eroding those communities' trust in law enforcement. Finally, a sprawling database with a low, exception-ridden standard for inclusion is not an effective one: in attempting to track so many individuals, law enforcement resources are diverted from actual security threats. Congress and the executive branch should institute much-needed reforms to address these concerns.

I. BACKGROUND

The VGTOF/KST File is part of a constellation of federal terrorism watchlists linked to the FBI's Terrorist Screening Database (TSDB). The TSDB contains sensitive but unclassified terrorist identity information such as names, dates of birth, photographs, iris scans, and fingerprints.¹ It was created in September 2003 by presidential directive with the goal of integrating several separate terrorist watchlists maintained by different agencies into one central repository.²

The entity within the FBI that is tasked with managing the TSDB is the Terrorist Screening Center (TSC). TSC is “the U.S. government’s consolidation point for known and suspected terrorist watchlist information, both foreign and domestic.”³ Names are added to the TSDB through the nomination process, which begins with a law enforcement or intelligence agency (see Figure 1). All nominations from these source agencies are sent to and reviewed by either the FBI or the National Counterterrorism Center (NCTC), a part of the Office of the

¹ Decl. Christopher M. Piehota at 2-3, *Am. Civil Liberties Union of Washington v. U.S. Dep’t of Justice*, No. C09-0642RSL (W.D. Wash. Mar. 24, 2011), ECF No. 46-1.

² *Id.* at 1-2.

³ Decl. David Hardy—Part 1 of 4, at 10, *ACLU of Washington v. U.S. Dep’t of Justice*, No. C09-0642RSL (W.D. Wash. June 18, 2010), ECF No. 39-2.

Director of National Intelligence, before being forwarded to the TSC for inclusion in the TSDB.⁴ Nominations of individuals suspected of involvement in domestic terrorism are reviewed by the FBI, and nominations of individuals suspected of involvement in international terrorism are reviewed by the NCTC.⁵

Figure 1. Terrorist Watchlist Nomination Process

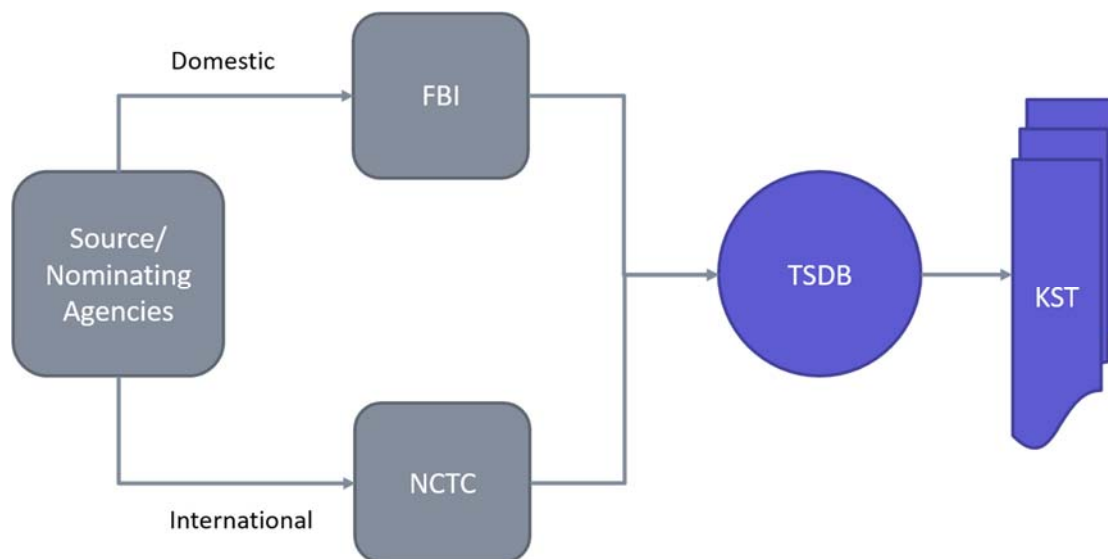

Although the FBI is the reviewing agency for domestic terrorism nominations, it can also be the source agency for both domestic and international terrorism nominations. Such nominations begin when an FBI field office submits a nomination form to the Terrorist Review and Examination Unit (TREX), the FBI headquarters unit that processes watchlist nominations resulting from open FBI investigations.⁶ TREX reviews these nominations and sends domestic terrorism nominations directly to the TSC, while international terrorism nominations are forwarded to the NCTC.⁷ The NCTC processes these nominations into its own database, the Terrorist Identities Datamart Environment (TIDE), and then feeds the names to the TSC, which enters them into the TSDB as well.⁸

⁴ OFFICE OF THE INSPECTOR GEN., U.S. DEP'T OF JUSTICE, AUDIT REPORT NO. 14-16, AUDIT OF THE FEDERAL BUREAU OF INVESTIGATION'S MANAGEMENT OF TERRORIST WATCHLIST NOMINATIONS (2014), at 1, 3 [hereinafter 2014 OIG REPORT].

⁵ *Id.* Domestic and international terrorism are distinguished primarily by whether the activities take place within the territorial jurisdiction of the United States. See *Definitions of Terrorism in the U.S. Code*, FED. BUREAU OF INVESTIGATION, <http://www.fbi.gov/about-us/investigate/terrorism/terrorism-definition> (last visited Jan. 5, 2016).

⁶ 2014 OIG REPORT, *supra* note 4, at 8.

⁷ *Id.* at 9.

⁸ *Id.* The TIDE database is prohibited from containing purely domestic terrorism information. *Id.*

Once a name has been entered into the TSDB, it is fed into other screening databases,⁹ such as the No Fly List (a list of individuals who are prevented from boarding a commercial aircraft for travel into or out of the United States or over U.S. airspace) and Selectee List (a list of individuals who are subjected to heightened screening at airports whenever they seek to board an airplane); the TSA's Secure Flight program (used to conduct pre-flight watchlist screening of passengers); the State Department's Consular Lookout and Support System (CLASS) (used to screen visa and passport applications); Customs and Border Protection's TECS Database, which customs officers use to screen individuals at points of entry;¹⁰ and VGTOF/ KST, which is accessible to law enforcement agencies across the United States through the National Crime Information Center (NCIC).¹¹ Information from the TSDB is also shared with more than a dozen other countries.¹²

As discussed further below, the criteria for nominations to the TSDB and to VGTOF/KST are vague, overbroad, and encompass innocent and First Amendment-protected conduct.

II. NEW DATA

The ACLU's FOIA litigation revealed the following information about VGTOF/KST File from 2003 to 2008:

- The total number of records in VGTOF/KST increased drastically from 2003 to 2008, undergoing a growth of nearly 2,000 percent. The total number of records continuously increased in this period except for one brief decline in late 2006.
- The vast majority of records were related to suspected international terrorism and were processed through the NCTC and the TSC.
- Military detainee entries and entries nominated by FBI legal attachés increased steadily from mid-2003 through the end of 2008.

⁹ *Id.*

¹⁰ *Id.* at 85-86.

¹¹ In August 2009, VGTOF was separated into the Gang File and the Known or Suspected Terrorist, or KST, file. *Id.* at 85. NCIC is a nationwide information system that provides the law enforcement community with information on various law enforcement data. *Id.* at 85 n.127.

¹² OFFICE OF THE INSPECTOR GEN., U.S. DEP'T OF HOMELAND SECURITY, NO. OIG-09-64, ROLE OF THE NO FLY AND SELECTEE LISTS IN SECURING COMMERCIAL AVIATION (2009), at 16.

- Large fluctuations in the data suggest that there were problems with data management and prompt review. Furthermore, there were more than 2,500 faulty records labeled “Unable to Identify” from 2006 to 2007, most of which subsequently became identified as “Unknown”—meaning that the government did not know if the individual was suspected of domestic or international terrorism using its vague and over broad criteria.

Total VGTOF Records

The total number of records in the VGTOF database increased dramatically over the relevant period (see Figure 2). The total increased from under 13,054 records in December 2003 to 272,198 records by December 2008, an approximately 2,000 percent growth over only a five-year period. This number includes both regular and silent hit entries (described in Section V). Even by the most conservative estimate, this means an addition of 259,144 new records to the database in a period of five years—an average of 142 new records per day.

Figure 2. Total VGTOF Entries

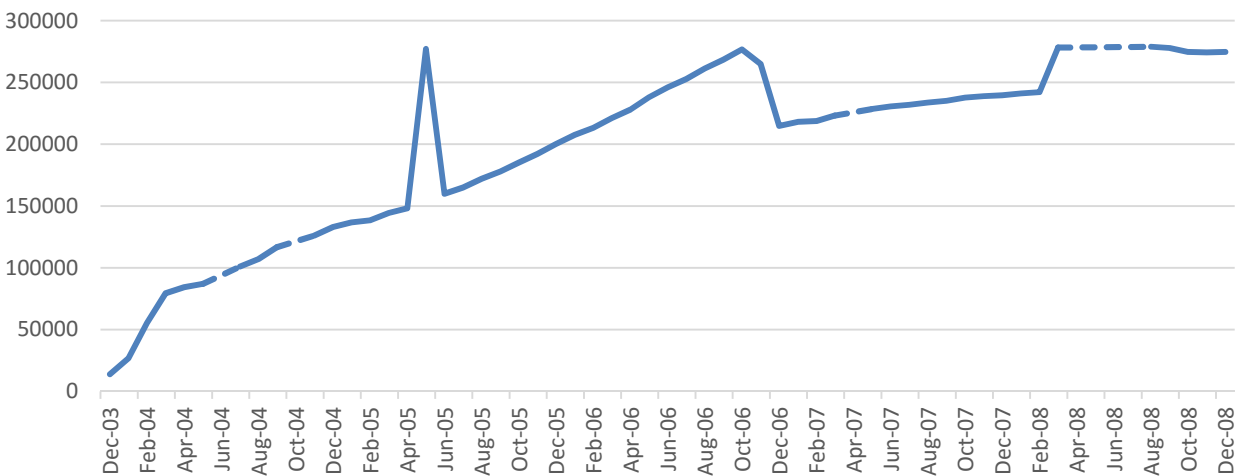

In addition to the steady and high rate of increase, the total number of records was also characterized by large fluctuations. In May 2005, the total spiked to more than 130,000, only to decrease again to previous levels in the following month. This was likely the result of “VGTOF Refresh,” a major clean-up initiative which deleted 7,264 records, modified and updated 113,000 records, and added 12,474 records that had been previously rejected from the VGTOF database.¹³ It is unclear, however, how and why the number decreased again precipitously in the next month, June 2005.¹⁴

¹³ FED. BUREAU OF INVESTIGATION, FBI NOMINATIONS & VGTOF TRAINING (2008), No. NCIC-VGTOF-8345 [hereinafter FBI NOMINATIONS & VGTOF TRAINING].

¹⁴ One change that occurred in June 2005 was that the TSDB was connected to the NCIC in near-real time. Prior to this change, the TSC only added, but did not modify or delete, records into the VGTOF database. *Id.* It is possible

These fluctuations in the number of total records in VGTOF suggest flaws in the data management. The addition or deletion of large numbers of records from the database indicates either that records were not inputted promptly and thus dumped into the system in bulk at a later date, or that a large number of records were not properly removed from VGTOF when they should have been, resulting in their wholesale removal later. This indicates the likely presence of false positives—individuals who should have been removed but whose records remained in the system—at any given time over this period.

Suspected Gang-Related versus Suspected Terrorism-Related Entries

From late 2003 to early 2004, the number of suspected terrorism entries underwent a dramatic increase, from over 9,000 to more than 50,000 (see Figure 3). This is especially notable when compared to the number of suspected gang entries, which remained steady over this period. The growth in suspected terrorism entries from December 2003 on is likely because of the establishment of the TSC, which began operating that month.¹⁵ Although VGTOF contained both suspected gang and terrorism information, these data show that the dramatic growth in the size of the database in the last decade is due to the expansion of the suspected terrorism records, which quickly outstripped the suspected gang-related records.

Figure 3. *Suspected Gang-Related versus Suspected Terrorism Entries*

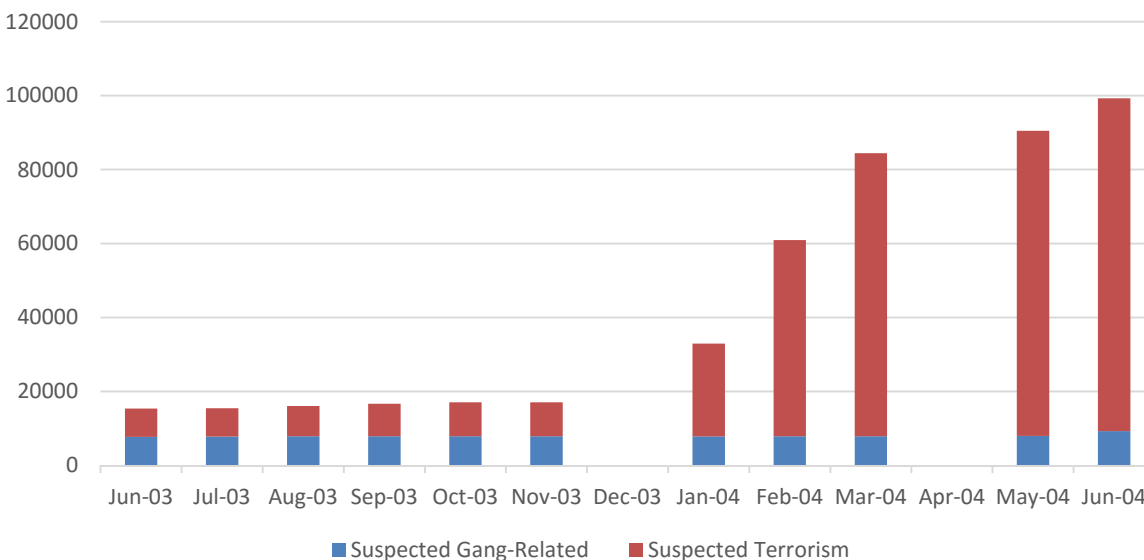

that this real-near-time connectivity allowed for some records to be deleted, but a roughly 130,000 reduction seems too high to be explained by this change.

¹⁵ OFFICE OF THE INSPECTOR GEN., U.S. DEP'T OF JUSTICE, AUDIT REPORT NO. 05-27, REVIEW OF THE TERRORIST SCREENING CENTER (2005), at 39 [hereinafter 2005 OIG REPORT]. The first data point for TSC-entered data in the FOIA documents also appeared in December 2003.

Domestic versus International Entries

The number of international entries vastly outstripped the number of domestic entries. Domestic entries hovered steadily around 500 or 600 entries for the duration of the period from November 2004 to November 2008 (see Figure 4). Fluctuations in the total number of entries in the database seems to be attributable to variations in the number of international entries, as they follow the same pattern.

Figure 4. *Domestic versus International Entries*

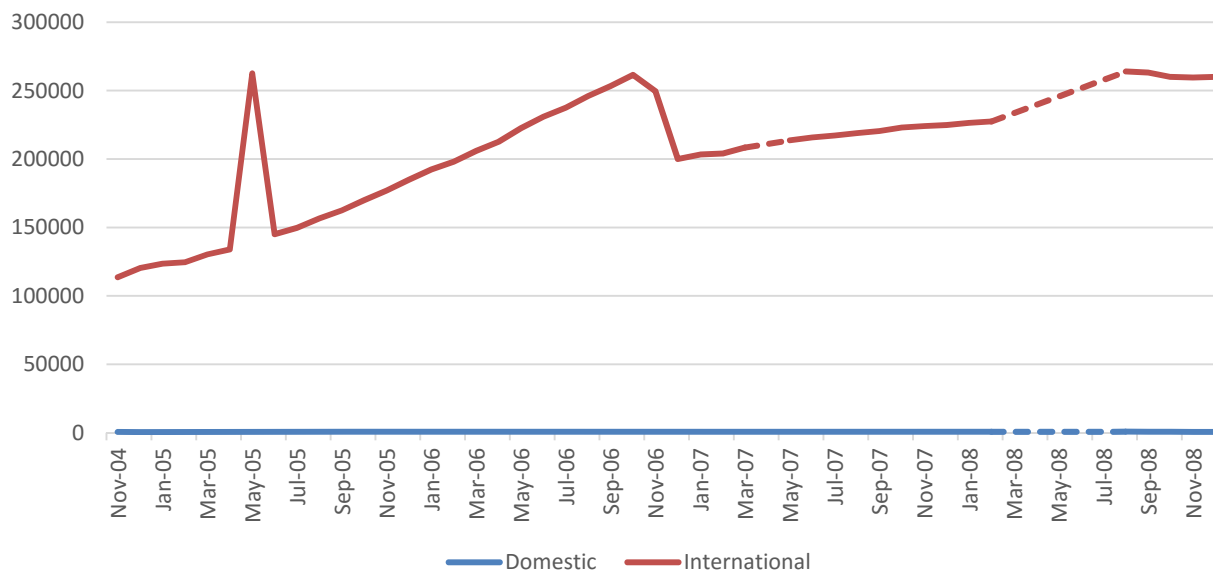

Nominating or Processing Entities

The FBI’s records categorize entries as either TSC records or FBI Field Office records. The precise definitions for these categorizations are unclear, but the vast majority of VGTOF’s records were categorized as TSC records, while only a small number were categorized as FBI Field Office records. Thus, the growth of the total number of records in VGTOF closely tracked the growth of records from the TSC (see Figure 5).

The number of records categorized as having come from FBI Field Offices grew from below 2,000 in February 2003 to over 12,000 by August 2006, a six-fold increase (see Figure 6). This number underwent a dramatic change in August 2004, when it plummeted to double digits, where it stayed until it shot back up to approximately the previous levels in February 2006. The drastic reduction in August 2004 is the result of a change which rescinded FBI Field Offices’ ability to effect changes directly in the VGTOF database for suspected terrorism records.¹⁶ After that date, only TREX and TSC, along with limited entities within the FBI’s Criminal Justice

¹⁶ FBI NOMINATIONS & VGTOF TRAINING, No. NCIC-VGTOF-8345, *supra* note 13.

Information Services Division (CJIS), had the ability to add, modify, and delete terrorism records in the VGTOF database.¹⁷ It is unclear what prompted the dramatic increase in February 2006.

Figure 5. Regular¹⁸ Entries from TSC

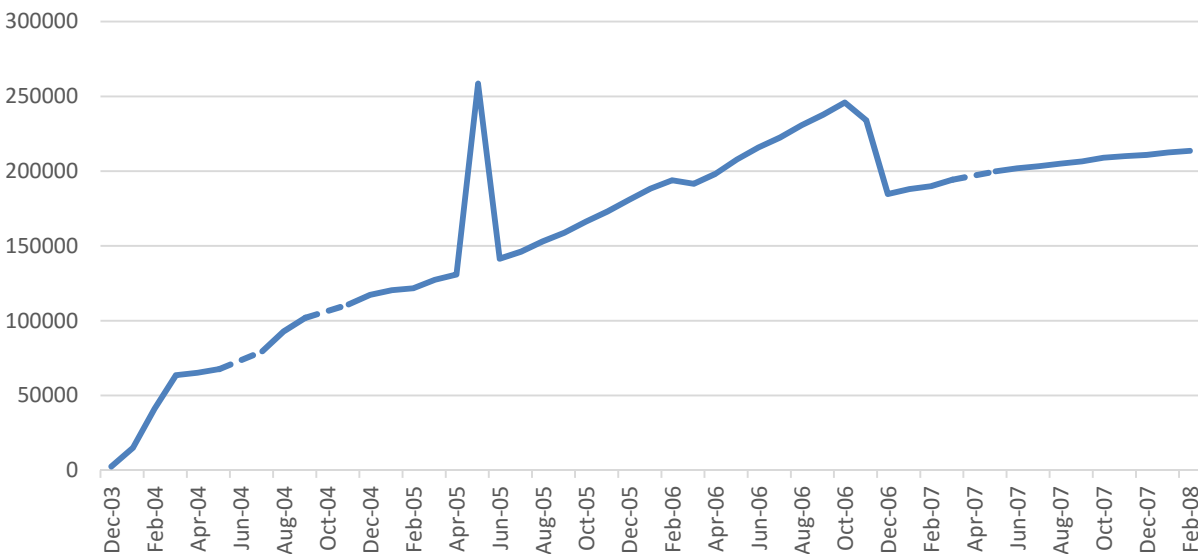
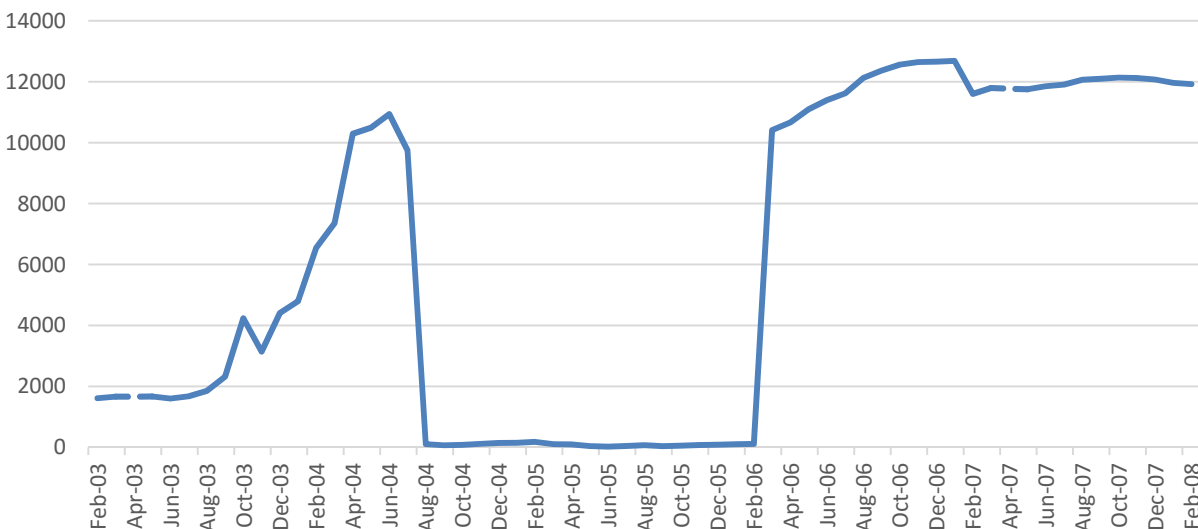

Figure 6. Regular Entries from Field Offices



The data obtained through FOIA also reveal the number of records entered by the NCTC compared to other entities (see Figure 7). Throughout the FOIA period, the majority of records in VGTOF were entered by NCTC, and the proportion of NCTC-entered records grew over time.

¹⁷ *Id.*

¹⁸ “Regular” entries do not include silent hit entries, which are discussed below in Section V.

From August 2005 to December 2008, 85 to 95 percent of all international records were entered by NCTC. This percentage increased over time, likely as the result of NCTC consolidating its status as the main unit for processing international entries.¹⁹

Figure 7. NCTC-Entered versus Non-NCTC-Entered Entries

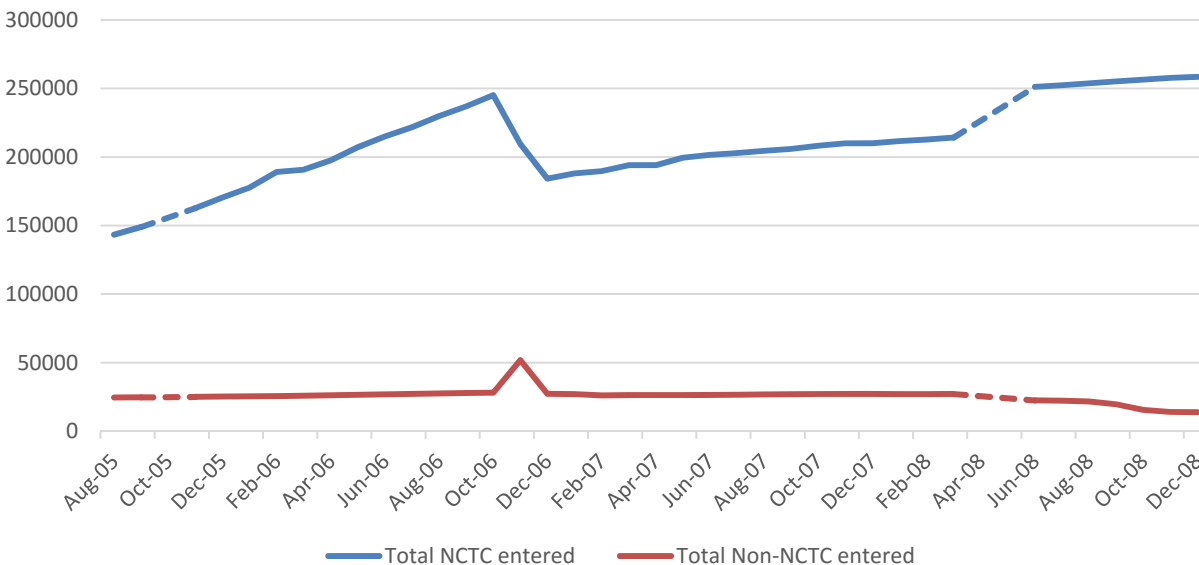

Military Detainees and Legal Attachés

During the period covered by the FOIA request, the VGTOF database also contained entries of U.S. military detainees and individuals nominated by FBI legal attachés. U.S. military detainees included individuals who were detained in Afghanistan, Guantanamo Bay, Pakistan, and Iraq. The FBI began collecting detainees’ fingerprints in Afghanistan in 2002.²⁰ For these military detainee records, the Department of Defense (DOD), rather than the FBI, made the determination that the individuals were suspected terrorists based on its own criteria, and DOD was considered the nominating agency.²¹ After increasing steadily from mid-2003 to mid-2005, the number of military detainee entries stabilized at around 14,000 (see Figure 8).

¹⁹ For example, TREX previously had a practice of directly creating entries for suspected international terrorists in VGTOF but ceased this practice in May 2008, instead sending the entries to the NCTC. Communication from Nat’l Sec. Branch to Counterterrorism, Re: Priority FBI IT Nominations Terrorist Screening Center (May 5, 2008), No. NCIC-VGTOF-10894; see OFFICE OF THE INSPECTOR GEN., U.S. DEP’T OF JUSTICE, AUDIT REPORT No. 07-41, FOLLOW-UP AUDIT OF THE TERRORIST SCREENING CENTER (2007), at 18-19 [hereinafter 2007 OIG REPORT].

²⁰ OFFICE OF THE INSPECTOR GEN., U.S. DEP’T OF JUSTICE, AUDIT REPORT No. 09-25, THE FEDERAL BUREAU OF INVESTIGATION’S TERRORIST WATCHLIST NOMINATION PRACTICES (2009), at xx [hereinafter 2009 OIG REPORT].

²¹ *Id.* By October 2008, the Department of Defense assumed responsibility for directly nominating detainees to the watchlist via the standard channels, rather than submitting them indirectly through the FBI’s Criminal Justice Information Services (CJIS) Division. *Id.* at xxi.

Figure 8. Military Detainee Entries

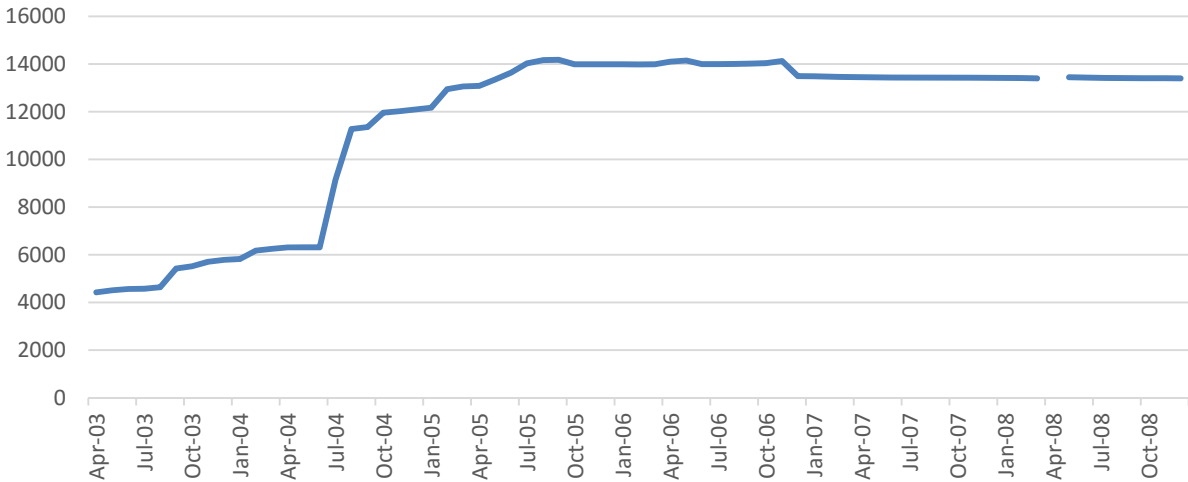

Legal attachés are representatives of the FBI in foreign countries whose primary mission is to maintain relationships with the foreign country’s principal law enforcement agencies.²² Entries resulting from nominations by FBI legal attachés increased steadily over the period from mid-2003 through late 2008, from fewer than 60 to over 800 records (see Figure 9). In general, the number of locations from which such entries originated also increased over this time period. In its 2009 review, the Office of the Inspector General raised concerns that many legal attaché entries had limited or no derogatory information supporting them and the FBI often conducted little or no independent analysis of the entries before forwarding them to the NCTC.²³

Figure 9. Legal Attaché Entries

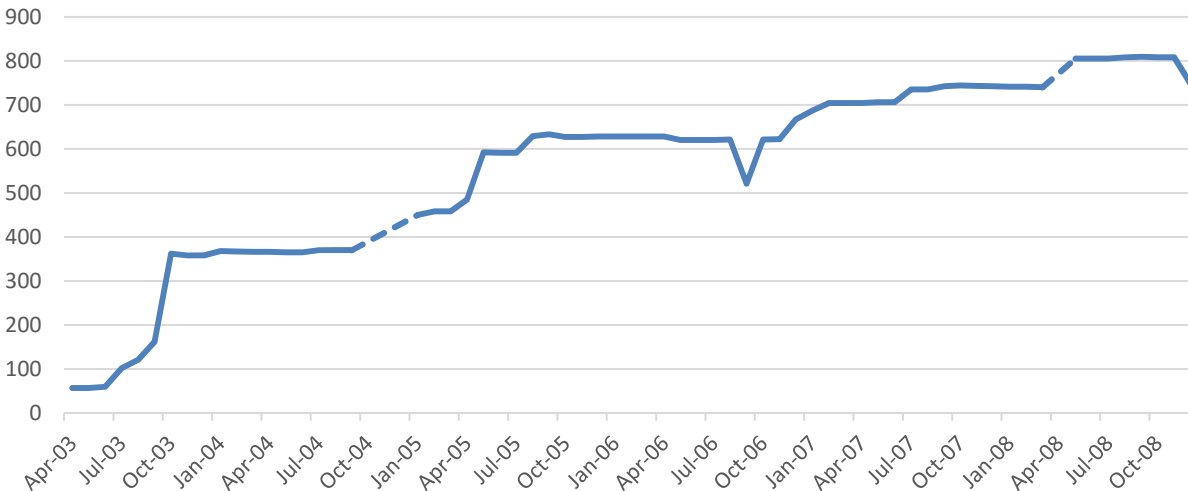

²² *Testimony*, FED. BUREAU OF INVESTIGATION, <http://www.fbi.gov/news/testimony/the-fbi2019s-legal-attache-program> (last visited Jan. 5, 2016).

²³ 2009 OIG REPORT, *supra* note 20, at xxii.

Unknown and Unidentifiable Records

Sets of records labeled as “Unknown” and “Unidentifiable” illustrate the extent to which the VGTOF database potentially contains flawed records. “Unknown” non-silent hit records are those that are not coded as domestic or international because that information is unknown. Another classification is “Unable to Identify,” the meaning of which is unclear from the documents.

The number of “Unable to Identify” records, initially in the hundreds in early 2006, increased more than tenfold in August 2006, hitting a peak of more than 2,500 records (see Figure 10). In August 2007, it appears that nearly 2,000 records were moved from the “Unable to Identify” category to the “Unknown” category. It is unclear how and why this change occurred, and whether and how the missing information was recovered for these categories to make them qualify for the “Unknown” category. In any case, these data show that at any time from mid-2006 to mid-2008, between 2,000 and 3,000 records were incomplete and potentially faulty entries.

Figure 10. Unknown VGTOF Records

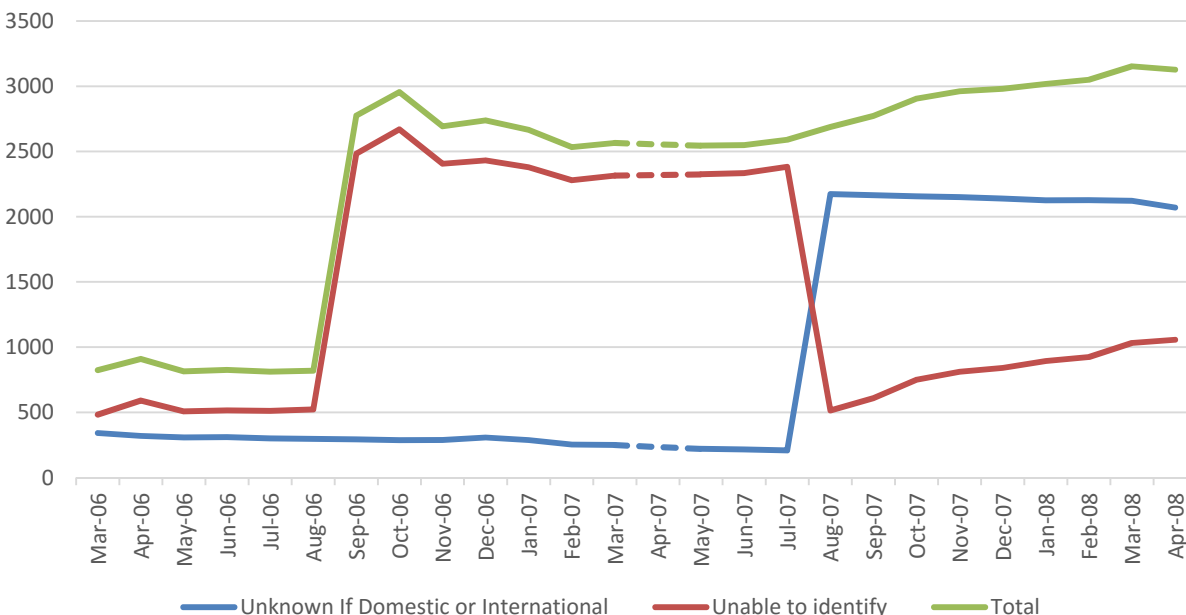

III. NOMINATIONS

Information obtained from the ACLU’s FOIA litigation, along with publically available documents and reviews from the U.S. Department of Justice’s Office of the Inspector General,

yielded the following conclusions on how the nomination and removal processes have developed over time.

- The procedure for nominating names for VGTOF/KST has become more centralized over time.
- In the meantime, the criteria for inclusion in the watchlist have become less concrete and less specific.
- What has been revealed regarding current practices suggests haphazard applications of vague standards to a variety of entries without regular oversight. During the initial nomination and review process, it is likely that some entries that did not meet the threshold nomination criteria were nevertheless entered into the watchlist.

A. Historical Developments

VGTOF – Early Process (1990s-2004)

The VGTOF database became operational as a file within the NCIC in 1995.²⁴ Prior to the September 11 attacks, the database had never been used for counterterrorism purposes,²⁵ although it contained nomination procedures for both suspected gang members and terrorism suspects alike. Documents governing the use of the file during that period suggest that any originating agency, be it a local law enforcement agency or an FBI office, could make either type of entry.²⁶ Under this system, the originating officer could enter two types of information into VGTOF: group entries (entries of suspected gang or terrorist organizations) and individual member entries (which would be tied to a gang or terrorist organization).²⁷

The NCIC Operating Manual for this period defined terrorist organizations as organizations that use force or violence in patterns of conduct with an aim to “intimidate or coerce a government, civilian population, or segment thereof, in furtherance of political or social objectives.”²⁸ The Manual also specified that terrorist group entries should be “the smallest

²⁴ Communication from Assistant Dir., FBI Criminal Investigative Div., to Special Agents in Charge and Legal Attachés (Mar. 25, 1996), No. NCIC-VGTOF-11653.

²⁵ Statement of Michael Kirkpatrick, Assistant Dir., FBI CJIS Div., CJIS Advisory Policy Board Minutes (June 5-6, 2002), No. NCIC-VGTOF-4269.

²⁶ NCIC 2000 Violent Gang and Terrorist Organization File (VGTOF) (Dec. 1999), at 3, 9. It does not appear there were any restrictions for what kinds of originating agencies can input entries, as long as the entry contains all the mandatory fields (header, message key, ORI identifier, group name, subgroup name, and point of contact). Many additional fields are “free text” and can include miscellaneous information. *Id.* at 4-5.

²⁷ *Id.* at 1.

²⁸ NCIC 2000 Operating Manual: Violent Gang and Terrorist Organization (VGTOF) File (Dec. 1999) ¶ 1.2.

identifiable segment, cell, or division which has been documented to be engaged or preparing to engage in qualifying terrorist activity.”²⁹

For individual member entries, the NCIC Manual provided the same criteria for suspected terrorists and suspected gang members: the individual either must have admitted to membership at the time of arrest or incarceration, or must satisfy two items on a composite list of indicators, including identification by a third party (either proven reliable or corroborated), observation by the originating law enforcement officer that the individual frequents the area near or associates with a group or affects the attire or markings of the group, or admission *after* arrest or incarceration that the individual is a member.³⁰ The individual entries could also contain caution and medical codes such as “Armed and Dangerous,” “Violent Tendencies,” and “Heart Condition.”³¹

Until at least July 2003, it appears that local law enforcement may have been able to enter information into VGTOF; the FOIA production revealed records labeled “Local Law Enforcement” entries, although it appears that they may only have been able to enter gang-related records, not terrorism-related records.³² Even after a policy change requiring all information to be input by the TSC, state and local law enforcement officers could submit names for nomination to local FBI Joint Terrorism Task Force centers, which then transmitted the nominations to FBI Headquarters for review.³³ Because records could remain in the database for years, some of the locally nominated names may have remained in the database long after the FBI phased out local officials’ nominating capabilities.³⁴

Centralization within FBI Headquarters (2004-2008)

The VGTOF nomination procedure became more centralized in August 2004, when the FBI eliminated field offices’ ability to add names to the VGTOF database directly.³⁵ Instead,

²⁹ *Id.* ¶ 1.3.

³⁰ *Id.* ¶ 9.2.

³¹ *Id.* ¶ 10.6. It is not clear if and how these supplemental identifiers are regulated; the manual only lists logistical procedures for entry, not substantive criteria.

³² See VGTOF Totals as of 7/31/2003, No. NCIC-VGTOF-8212. These “Local Law Enforcement Entries” were separate from, and appeared alongside, “FBI Field Office Entries.” However, the data contained disclaimers stating, “Local law enforcement has not entered any Terrorist subject records—CTAs have entered some test records and this count also includes records entered by Legats.” *Id.* In July 2003, 107 terrorism-related records are labeled “Local Law Enforcement Entries,” the only month for which a positive number appears (the number in June 2003 was zero and the category ceased appearing after July 2003). *Id.*

³³ Communication from CJIS Programs Dev. Section/Glob. Initiatives Unit to CJIS and Counterterrorism, Re: National Crime Information Center Technical and Operational Update (Nov. 7, 2005), No. NCIC-VGTOF-6886.

³⁴ For example, at the time of the policy change rescinding FBI local office entry powers, the record owners conducted “no type of qualify [sic] review.” FBI NOMINATIONS & VGTOF TRAINING, No. NCIC-VGTOF-8345, *supra* note 13.

³⁵ *Id.*

only TREX, the TSC, and some entities within the FBI's Criminal Justice Information Services (CJIS) Division could make entries in VGTOF.³⁶ FBI field offices and legal attachés could submit names to the TREX office, but they could not create new records or alter existing records directly. For domestic terrorism entries, TREX sent the nominations it received to the TSC directly for inclusion in the TSDB; for international entries, TREX entered the information into VGTOF directly and then submitted the nomination to the NCTC, which entered it into TIDE, which in turn fed the record into the TSDB.³⁷ Once included in the TSDB, domestic entries were electronically distributed to downstream screening databases, including VGTOF.³⁸ Because international entries were already entered into VGTOF by TREX, the TSC did not export the record it received from TIDE to VGTOF.³⁹

FBI Headquarters' newly centralized control over the nomination process also marked the end of concrete, specific criteria for nominations. In the NCIC 2000 Operating Manual, the government's criteria for nominations included a specific list of behaviors it identified as indicating terrorist association or activity.⁴⁰ By early 2005, the list had expanded to encompass vague, broad criteria such as "Terrorist acting alone" and "Subject is suspected or believed to be associated with terrorism or a terrorist organization."⁴¹ By late 2005, the group entry criteria were deleted entirely from the operating procedures for VGTOF terrorism entries.⁴² By mid-2006, individual entry criteria too appeared to fall away, giving way to a generalized standard: nominees to the TSDB needed only to "demonstrate a nexus to terrorism, or [be the subject of]

³⁶ *Id.*

³⁷ 2007 OIG REPORT, *supra* note 19, at 18.

³⁸ *Id.*

³⁹ *Id.*

⁴⁰ NCIC 2000 Operating Manual: Violent Gang and Terrorist Organization (VGTOF) File (Dec. 1999) ¶ 9.2.

⁴¹ Operator's Lesson Plan: Violent Gang and Terrorist Organization File (Feb. 2005), at 209. The new criteria required two of the following:

- a. Admitted membership in a gang or terrorist organization at the time of his/her arrest or incarceration;
- b. Has been identified by an individual of proven reliability as a group member;
- c. Has been identified by an individual of unknown reliability as a group member and that information has been corroborated in significant respects;
- d. Has been observed by members of the entering agency to frequent a known group's area, associate with known group members and/or affect that group's style of dress, tattoos, hand signals, or symbols;
- e. Has been arrested on more than one occasion with known group members for offenses consistent with group activity;
- f. Has admitted membership in the identified group at any time other than arrest or incarceration.
- g. Terrorist acting alone.
- h. Subject is suspected or believed to be associated with terrorism or a terrorist organization.

Id. Note that (g) and (h) were new and expanded the breadth of the criteria.

⁴² Communication from CJIS Programs Dev. Section/Glob. Initiatives Unit to CJIS and Counterterrorism, Re: National Crime Information Center Technical and Operational Update (Nov. 7, 2005), No. NCIC-VGTOF-6886 to NCIC-VGTOF-6890.

an active investigation to ascertain whether a nexus to terrorism exists.”⁴³ Some handling codes required “reasonable, articulable suspicion of criminal domestic or international terrorism activity,” but others did not.⁴⁴ This ambiguity, and the low threshold for nomination, exacerbate concerns that the criteria led to the inclusion of entries that should not have been included.

TSC Control, Dissolution of VGTOF, and Creation of the KST (2008-2009)

The move towards a centralized nominations process with broad entry criteria continued. Although the TSC had been formally designated as the central watchlisting agency in 2003,⁴⁵ some significant gaps remained in the process prior to 2008. For example, TREX had an informal practice of entering international terrorist names directly into VGTOF and then forwarding them to NCTC, thus circumventing NCTC review.⁴⁶ In September 2007, the Office of the Inspector General recommended that TREX stop directly creating VGTOF records for international terrorist nominations before sending them to the NCTC,⁴⁷ TREX ultimately implemented this recommendation in May 2008.⁴⁸

By August 2009, the FBI had split VGTOF into two new, standalone files: the Gang file and the Known or Suspected Terrorist (KST) file, which both remain accessible through NCIC.⁴⁹ The KST file followed the same nomination process as had terrorism-related entries in VGTOF: the TSC is the central body with final decision-making power over whether to include nomination subjects into the TSDB, and the TSDB then populates the KST and other downstream databases.⁵⁰

B. Current Nomination Procedures and Criteria

As outlined in Section I, the current process for source agencies to nominate new entries is as follows:

⁴³ STANDARD OPERATING PROCEDURES: NOMINATION PROCESS, TERRORIST SCREENING CENTER NOMINATIONS AND DATA INTEGRITY UNIT (Aug. 2, 2006), No. NCIC-VGTOF-8373.

⁴⁴ *Id.*, No. NCIC-VGTOF-8374.

⁴⁵ 2014 OIG REPORT, *supra* note 4, at 18 n.44.

⁴⁶ 2007 OIG REPORT, *supra* note 19, at 18-19.

⁴⁷ *Id.*

⁴⁸ Communication from Nat'l Sec. Branch to Counterterrorism, Re: Priority FBI IT Nominations Terrorist Screening Center (May 5, 2008), No. NCIC-VGTOF-10894.

⁴⁹ NCIC 2000 Operating Manual Issued in 1999 with Technical and Operational Updates (TOU) Incorporated – Known or Appropriately Suspected Terrorists (KST) File (Aug. 2, 2009), No. NCIC-VGTOF-707 [hereinafter 2009 NCIC Operating Manual]. KST was fully implemented much later, in June 2011. 2014 OIG REPORT, *supra* note 4, at 36.

⁵⁰ 2014 OIG REPORT, *supra* note 4, at 8.

- 1) The source agency submits names to either the FBI (domestic terrorism) or the NCTC (international terrorism).⁵¹
- 2) The FBI or the NCTC reviews the nominations.⁵²
- 3) The FBI or the NCTC submits approved names to the TSC for inclusion in the TSDB.⁵³
- 4) The TSC exports the TSDB entries to downstream databases, including KST (formerly VGTOF).⁵⁴

For entries that originate with an FBI field office, the nomination process is as follows:

- 1) The FBI field office submits domestic and international nominations to TREX.⁵⁵
- 2) TREX “Technical Information Specialists” review the nominations.⁵⁶
- 3) TREX sends domestic nominations to the TSC and international nominations to the NCTC.⁵⁷
- 4) The NCTC enters the approved names into the TIDE database, which is then exported to the TSC.⁵⁸
- 5) The TSC conducts a final review and imports all approved entries to the TSDB.⁵⁹
- 6) The TSDB entries then flow to downstream databases, including KST (formerly VGTOF).⁶⁰

Nominations for inclusion in the TSDB (and therefore in KST) must meet a “reasonable suspicion” standard based on “articulable intelligence or information which, based on the totality of the facts . . . reasonably warrants a determination that the subject is known or is suspected to be (or has been) knowingly engaged in conduct constituting, in preparation for, in aid of, or related to, terrorism or terrorist activities.”⁶¹ However, nominating agencies are instructed to establish their own processes for ensuring the quality and accuracy of the nominations, and it is not clear how consistent or meaningful those agencies’ quality control is.⁶² No entity ensures that

⁵¹ *Id.* at 1, 3.

⁵² *Id.* at 3.

⁵³ *Id.*

⁵⁴ *Id.* at 9.

⁵⁵ *Id.* at 8.

⁵⁶ *Id.*

⁵⁷ *Id.* at 9.

⁵⁸ *Id.*

⁵⁹ *Id.*

⁶⁰ *Id.*

⁶¹ *Id.* at 7. The government’s leaked 2013 Watchlisting Guidance defined terrorism and terrorist activities as “violent acts or acts dangerous to life, property, or infrastructure” in violation of U.S. law and appear to be intended to “intimidate or coerce a civilian population; to influence the policy of a government by intimidation or coercion; or, to affect the conduct of a government by mass destruction, assassination, kidnapping, and hostage-taking.” WATCHLISTING GUIDANCE (Mar. 2013) ¶ 1.14 [hereinafter 2013 WATCHLISTING GUIDANCE].

⁶² 2013 WATCHLISTING GUIDANCE ¶¶ 1.43, 1.45. The Guidance states that “[e]ach NOMINATING AGENCY should implement processes designed to ensure that nominations are free from errors, that recalled or revised information is reviewed regularly, and that necessary corrections to nominations based on those revisions/retractions

the “reasonable suspicion” standard is consistently applied by nominating officers or analysts. As explained in greater detail below, the reasonable suspicion standard is deeply problematic for numerous reasons, including that it permits the use of uncorroborated or questionably reliable information, necessarily entails a significant risk of error, and makes it likely that individuals will be nominated for, and included in, the TSDB and KST based on conduct that is innocent or protected under the First Amendment.

It is not clear what, if any, guidelines govern the nominations of source agencies other than the FBI. According to a 2014 OIG report, however, three categories of individuals can be nominated by the FBI for inclusion in the KST File: 1) subjects of full investigations, 2) subjects of preliminary investigations, and 3) non-investigative subjects.⁶³

Full investigations are authorized when there are “specific and articulable facts giving reason to believe that a criminal activity or a threat to national security may exist.”⁶⁴ Subjects of full investigations are presumed to meet the “reasonable suspicion” standard because of the FBI’s internal criteria for expanding a preliminary investigation to a full investigation.⁶⁵

Preliminary investigations are authorized when “there exists any allegation or information indicative of possible criminal activity or threats to the national security.”⁶⁶ Thus, the FBI initiates a preliminary investigation when it does not have enough evidence to meet the standard for a full investigation, and yet it may nevertheless nominate individuals under preliminary investigation for inclusion in the watchlist. Indeed, subjects of preliminary investigations may not meet the reasonable suspicion standard for watchlisting.⁶⁷ As with the watchlisting criteria, the FBI’s guidelines for preliminary investigations are vague and overbroad, permitting intrusive investigations of people for lengthy periods even when the government does not have facts to meet its own low “reasonable indication” standard for showing that anyone has violated the law.

A third type of nomination, the “non-investigative subject nomination,” allows for the nomination of individuals who are not the subjects of an open FBI investigation. Although the specific criteria for who may be nominated as non-investigative subjects are unclear,⁶⁸ these

are made. NOMINATING AGENCIES should, to the extent possible given the nature of the reporting, verify the accuracy and reliability of the information included in nominations.” *Id.* at ¶ 1.43.

⁶³ 2014 OIG REPORT, *supra* note 4, at 33. FBI field offices generally sort terrorism cases into three categories for action: assessments, preliminary investigations, and full investigations. “Assessment” subjects generally are not forwarded for nomination to terrorist watchlists. *Id.* at 7-8.

⁶⁴ *Id.* at 7.

⁶⁵ *Id.*

⁶⁶ *Id.*

⁶⁷ *Id.*

⁶⁸ There are three criteria, but they are redacted in the 2004 OIG Report. *Id.* at 66.

nominations could include names that the FBI receives from foreign governments through legal attachés or from other agencies, such as the Drug Enforcement Administration (DEA).⁶⁹ One document from the FOIA production describes non-investigative subject nominations by FBI Headquarters as “individuals [who] are ‘on the radar’ but are not currently under investigation.”⁷⁰ A 2009 OIG report found that the review process for such nominations is “weak or nonexistent.”⁷¹ Similarly, a 2014 OIG report found that the FBI could not “readily provide an accurate accounting of the actions that were taken regarding the watchlisting of non-investigative subjects.”⁷² As the foregoing analysis makes clear, the FBI’s watchlisting practices for non-investigative subjects are ripe for abuse and permit the inclusion of names submitted by foreign governments (which may have their own reasons for seeking to watchlist dissidents and opponents) under standards that fall short of the FBI’s already low threshold for nomination.

The FBI’s use of the “reasonable suspicion” standard is problematic for numerous reasons:

- First, reasonable suspicion, as used here, is a very low standard that can be met with uncorroborated or even questionably reliable information and, on its face, does not require that it be more probable than not that an individual is involved in terrorism-related activities. Such a low threshold for nomination injects a significant risk of error into the nomination process and makes it likely that individuals will be nominated for, and included in, the TSDB and KST based on conduct that is innocent or protected under the First Amendment. The 2013 Watchlisting Guidance also includes numerous exceptions to the reasonable suspicion requirement that make it significantly easier to watchlist non-citizens, leaving them particularly vulnerable to watchlisting based on inaccurate, incomplete, or spurious information.⁷³
- Second, nominations do not always appear to undergo review to determine whether they actually meet the “reasonable suspicion” standard. This is especially alarming in light of the fact that FBI field agents do not always understand the downstream effects of nominating an individual for entry into the TSDB.⁷⁴
- Third, the nominations of preliminary investigation subjects and non-investigatory subjects raise questions about how individuals who do not meet the criteria for full

⁶⁹ 2014 OIG REPORT, *supra* note 4, at 66.

⁷⁰ FBI NOMINATIONS & VGTOF TRAINING, No. NCIC-VGTOF-8346, *supra* note 13.

⁷¹ 2009 OIG REPORT, *supra* note 20, at v.

⁷² 2014 OIG REPORT, *supra* note 4, at 70.

⁷³ 2013 WATCHLISTING GUIDANCE ¶ 1.47.

⁷⁴ 2009 OIG REPORT, *supra* note 20, at xv (“[M]any agents did not realize that the watchlist feeds several downstream databases used by other segments of the law enforcement community.”).

investigation—that is, “specific articulable facts giving reason to believe” a threat might exist⁷⁵—could nevertheless satisfy the definition of “reasonable suspicion” required for entry into the TSDB, which is “articulable intelligence” and an “objective factual basis.”⁷⁶

- Fourth, the OIG reports suggest that there has been no systematic review for whether the nominating field office correctly determined that the reasonable suspicion standard had been met.⁷⁷ In 2007, the OIG noted that the TSC had been attempting a record-by-record audit review of watchlist entries but that the TSC was unlikely to finish the process before 2012, and it is not clear if the review was ever completed.⁷⁸ In addition, it is not clear how meaningful the review process was. While the TSC’s process in March 2006 included reviewing *incoming* records for a “nexus” to terrorism,⁷⁹ review of *existing* records appeared limited to special targeted reviews of the No Fly List and other specific categories, as well as situations where an external encounter with a subject indicated that information would need to be added or changed.⁸⁰ These are not systematic reviews of historical records for substantive sufficiency to meet the reasonable suspicion standard.
- Fifth, there are few external incentives for officials within the TSC and field offices to exercise caution when entering subjects according to reasonable suspicion standards. Because the information underlying watchlisting entries is secret, and because there is no judicial review of watchlisting decisions,⁸¹ officials do not have the same incentives as police officers (who face the suppression of evidence if their determination of reasonable suspicion or probable cause is incorrect) to adhere carefully to applicable evidentiary standards. In addition, those with decision-making authority over watchlist nominations may not fully understand the ramifications of placement on a watchlist.⁸²

⁷⁵ 2014 OIG REPORT, *supra* note 4, at 7.

⁷⁶ 2013 WATCHLISTING GUIDANCE ¶ 3.4.

⁷⁷ The 2013 Watchlisting Guidance suggests that TSC reviews nominations for whether they meet watchlisting standards. *Id.* ¶ 1.46. However, it also states that a nomination will be accepted if it “contains the minimum substantive derogatory criteria and the minimum identifying information.” *Id.* ¶ 1.56.2.1. It is not clear whether this is systematic review of whether nominations meet the reasonable suspicion standard, or simply a review to make sure the entry is complete.

⁷⁸ 2007 OIG REPORT, *supra* note 19, at xvi.

⁷⁹ *Id.* at xii, 28-29.

⁸⁰ *Id.* at 30.

⁸¹ The operating manual for VGTOF specifically states, “Because VGTOF information is based, in part, on investigative information not previously subject to independent judicial review, strict adherence to policy on the security, use, and dissemination of VGTOF information is necessary.” NCIC 2000 Operating Manual: Violent Gang and Terrorist Organization (VGTOF) File (Dec. 1999), at 1.

⁸² 2009 OIG REPORT, *supra* note 20, at xv (“[M]any agents did not realize that the watchlist feeds several downstream databases used by other segments of the law enforcement community.”).

- Sixth and finally, although the 2013 Watchlisting Guidance states that “First Amendment protected activity alone shall not be the basis for nominating an individual for inclusion on the Terrorist Watchlist,”⁸³ it is clear that First Amendment-protected activity may constitute part of the basis for inclusion in the TSDB. Indeed, under the Guidance, a single Facebook post, Tweet, or anonymous letter may provide the “reasonable suspicion” necessary to watchlist an individual.⁸⁴

Given these deficiencies in the nomination process and standard, it is perhaps unsurprising that even someone who has been exonerated after investigation or even prosecution can nevertheless remain on the watchlist. An FBI document from 2009 explicitly states that individuals who have been acquitted of terrorism-related crimes, and those whose charges have been dismissed, can nevertheless remain on the watchlist provided that reasonable suspicion remains.⁸⁵ Even when an FBI investigation has closed and the field office is theoretically required to submit a request to remove the individual from the watchlist, the FBI case agent can petition to keep that individual on the watchlist by nominating him or her as a non-investigative subject.⁸⁶ In addition, individuals exonerated by an FBI investigation can remain in TIDE based on a nominating agency’s independent determination that the individual is a known or suspected terrorist (again according to vague and overbroad criteria) or under an exception to the reasonable suspicion standard.⁸⁷

IV. ENCOUNTERS WITH LOCAL LAW ENFORCEMENT

The documents obtained through FOIA litigation, along with other publicly available documents, show the following about law enforcement officers’ “encounters”⁸⁸ with watchlisted individuals:

- When local law enforcement encountered an individual on VGTOF/KST, such as during a routine traffic stop, and the officer runs a search of the individual’s name in the NCIC

⁸³ 2013 WATCHLISTING GUIDANCE ¶ 1.19, 3.9. For example, at ¶ 3.13.8.1, the Guidance states: “A sympathizer or supporter of terrorism should be nominated if the support is operational in nature. If support is merely ideological, the individual should not be nominated.”

⁸⁴ *Id.* ¶ 3.6 (“Single source information, including but not limited to ‘walk-in’, ‘write-in’, or postings on social media sites, however, should not automatically be discounted merely because of the manner in which it was received.”).

⁸⁵ Communications from Counterterrorism to All Field Offices and All Legats, Re: Counterterrorism Program Guidance/Watchlisting/Administrative and Operational Guidance (Dec. 7, 2009), http://epic.org/privacy/airtravel/EPIC_DOJ_FOIA_NoFlyList_09_13_11_CT_Guidance2.pdf, ¶ 1.7.

⁸⁶ *Id.* ¶ 1.8.

⁸⁷ 2013 WATCHLISTING GUIDANCE 28 n.34.

⁸⁸ “Encounter” means “local, state, tribal, or federal law enforcement and homeland security screeners have come across a known or suspected terrorist during normal job duties (e.g., traffic stops, checking of airplane manifests, or evaluating an application for a U.S. passport or visa).” 2009 OIG REPORT, *supra* note 20, at 2 n.42.

database, the officer ordinarily received an NCIC “hit” showing that individual had been watchlisted as a terrorism suspect.⁸⁹

- In the overwhelming majority of cases, an officer who encountered a watchlisted individual was not encountering a person with an outstanding arrest warrant. Instead, the individual was on the list for tracking and information-gathering purposes only.⁹⁰
- Although the TSC issued some standard advisory messages to law enforcement officers on how to conduct these encounters, the disclosure of individuals’ watchlisting status to local law enforcement officers made the individuals vulnerable to intensified monitoring and investigative interest.
- Between December 2003 and May 2007, individuals in over 40 percent of all encounters that were referred to the TSC Call Center were a false match and were not actually on the watchlist.⁹¹

A. The Encounter Process

When a local officer queries the NCIC about an individual who is the subject of an entry in VGTOF/KST, the officer generally receives a message through NCIC about the individual. Entries in VGTOF/KST are categorized by the type of message—or “handling code”—that NCIC returns to the querying officer. As of 2009, KST utilized three separate handling codes (described in detail below): Handling Code 1 for subjects with arrest warrants, Handling Code 2 for subjects who are slated to receive DHS detainers, and Handling Code 3 for the rest.⁹²

The vast majority of VGTOF/KST entries appear to have been Handling Code 3, the catch-all category. As of March 2007, 96.8 percent of the VGTOF entries were Handling Code 3, 0.5 percent were Handling Code 2 (detainers), and 2.1 percent were Handling Code 1 (arrest warrants).⁹³ The remaining 0.6 percent of entries were “Other,” presumably meaning silent hit entries (discussed in Section V).⁹⁴ Thus, it appears that VGOTF/KST in practice has primarily

⁸⁹ This is not true for silent hit entries, which are discussed in Section V.

⁹⁰ In other words, the individual would be free to go after the officer records the encounter.

⁹¹ A 2007 OIG audit indicated that only 53.4 percent of encounters called into the TSC by local officials were matches, while in 43.4 percent of these calls, the encountered individual did not match the watchlisted identity. The other 3.2 percent of encounters were indeterminate and referred to the FBI by the TSC Call Center staff. 2007 OIG REPORT, *supra* note 19, at vi.

⁹² Communications from Counterterrorism to All Field Offices and All Legats, Re: Counterterrorism Program Guidance/Watchlisting/Administrative and Operational Guidance (Dec. 7, 2009), http://epic.org/privacy/airtravel/EPIC_DOJ_FOIA_NoFlyList_09_13_11_CT_Guidance2.pdf.

⁹³ 2007 OIG REPORT, *supra* note 19, at 9.

⁹⁴ *Id.*

identified and tracked the whereabouts of its subjects, and very rarely has resulted in arrests or detention.

For the vast majority of subjects, which fall under Handling Code 3, VGTOF/KST has acted as an information-collecting tool for the TSC. In a 2006 meeting of the NCIC Advisory Policy Board, the director of the TSC stated that VGTOF's purpose is to ensure that "for the very first time, state and local officers had some ability to know that someone they pulled over could be on the watch list,"⁹⁵ prompting the local officer who encountered someone on the watchlist to call the TSC and provide the TSC with additional information about the subject. The TSC's practice has been to record such information using a tool called the "Encounter Management Application," which was implemented in July 2004 and contains records of all encounters since the TSC became operational.⁹⁶ Information gathered from the encounter is analyzed and "used to enhance existing watchlist records," which the intelligence community uses to assess threats and conduct investigations.⁹⁷

When the TSC receives a call from an encountering official based on a VGTOF/KST hit,⁹⁸ it can look into the nominating agency's system to determine if the individual apprehended is indeed the watchlisted suspect, and if so, if action should be taken. For domestic encounters, the FBI "must be consulted prior to taking any action based on ENCOUNTERS with a person who is a POSITIVE MATCH with KNOWN or SUSPECTED TERRORIST."⁹⁹ The 2013 Watchlist Guidance adds that "[e]specially sensitive ENCOUNTERS often require coordination and situational updates with the White House, Northern Command (NORTHCOM), and FBI's Counterterrorism-Watch."¹⁰⁰ In the vast majority of instances, the authorities have taken no action and have released the individual without telling him that he is on a watchlist.¹⁰¹

For local officers, the discovery that a traffic violator is on a terrorist watchlist has sometimes led to actions that are not prescribed by the handling code messages. For example, the TSC acknowledged that in the early days of the implementation, some encountering officers had

⁹⁵ Statement of Donna Bucella, Dir., Terrorist Screening Ctr., CJIS Advisory Policy Board Minutes (June 22-23, 2006), No. NCIC-VGTOF-5411. As discussed in Section V, this is not the case for silent hit entries, for which VGTOF/KST information is hidden from the view of state and local officers.

⁹⁶ 2007 OIG REPORT, *supra* note 19, at 6.

⁹⁷ 2014 OIG REPORT, *supra* note 4, at 5; 2013 WATCHLISTING GUIDANCE ¶ 5.14.

⁹⁸ It is likely that, when NCIC is queried and there is a VGTOF/KST hit, that the TSC first received an electronic notification that there has been a hit, and then (if the encountering official follows the Handling Code instructions) a phone call from the encountering officer. The 2013 Watchlist Guidance states that "[n]ame-based transaction queries by law enforcement personnel (*e.g.*, traffic stops) made to the FBI's National Crime Information Center . . . that match a name in the KSTF . . . are routed electronically to TSC for confirmation and subsequent processing as an ENCOUNTER." 2013 WATCHLISTING GUIDANCE ¶ 5.8.1.

⁹⁹ 2013 WATCHLISTING GUIDANCE ¶ 5.18.

¹⁰⁰ *Id.* ¶ 5.13.1.

¹⁰¹ 2007 OIG REPORT, *supra* note 19, at 9.

been “a little aggressive and . . . pulled the person out of the car” when they saw the NCIC hit telling them to contact the TSC.¹⁰²

B. Description of Handling Codes

Handling Code 1 applies to individuals with outstanding arrest warrants in the NCIC Wanted Persons File.¹⁰³ As of 2009, Handling Code 1 read as follows:

LAW ENFORCEMENT SENSITIVE INFORMATION

WARNING – APPROACH WITH CAUTION.

THIS INDIVIDUAL IS ASSOCIATED WITH TERRORISM AND IS THE SUBJECT OF AN ARREST WARRANT, ALTHOUGH THE WARRANT MAY NOT BE RETRIEVABLE VIA THE SEARCHED IDENTIFIERS. IF AN ARREST WARRANT FOR THE INDIVIDUAL IS RETURNED IN YOUR SEARCH OF NCIC, DETAIN THE INDIVIDUAL PURSUANT TO YOUR DEPARTMENT’S PROCEDURES FOR HANDLING AN OUTSTANDING WARRANT, AND IMMEDIATELY CONTACT THE TERRORIST SCREENING CENTER AT (866) XXX-XXXX FOR ADDITIONAL DIRECTION.

IF AN ARREST WARRANT FOR THE INDIVIDUAL IS NOT RETURNED, USE CAUTION AND IMMEDIATELY CONTACT THE TSC AT (866) XXX-XXXX FOR ADDITIONAL DIRECTION WITHOUT OTHERWISE EXTENDING THE SCOPE OR DURATION OF THE ENCOUNTER. IF YOU ARE A BORDER PATROL OFFICER IMMEDIATELY CALL THE NTC.

UNAUTHORIZED DISCLOSURE OF TERRORIST WATCHLIST INFORMATION IS PROHIBITED. DO NOT ADVISE THIS INDIVIDUAL THAT THEY MAY BE ON A TERRORIST WATCHLIST. INFORMATION THAT THIS INDIVIDUAL MAY BE ON A TERRORIST WATCHLIST IS PROPERTY OF THE TSC AND IS A FEDERAL RECORD PROVIDED TO YOUR AGENCY THAT MAY NOT BE DISSEMINATED OR USED IN ANY PROCEEDING WITHOUT THE ADVANCE AUTHORIZATION OF THE TSC.

LAW ENFORCEMENT SENSITIVE INFORMATION¹⁰⁴

Handling Code 2 appears to pertain mainly to watchlisted individuals who are subject to current or future DHS detainees. The future detainees apply to those who would be given

¹⁰² Statement of Donna Bucella, Dir., Terrorist Screening Ctr., CJIS Advisory Policy Board Minutes (June 22-23, 2006), No. NCIC-VGTOF-5411.

¹⁰³ Communications from Counterterrorism to All Field Offices and All Legats, Re: Counterterrorism Program Guidance/Watchlisting/Administrative and Operational Guidance (Dec. 7, 2009), http://epic.org/privacy/airtravel/EPIC_DOJ_FOIA_NoFlyList_09_13_11_CT_Guidance2.pdf, ¶ 1.2.1.1.

¹⁰⁴ 2009 NCIC Operating Manual, *supra* note 49, No. NCIC-VGTOF-708.

detainers if they encounter law enforcement.¹⁰⁵ People with sealed federal indictments can also be subject to Handling Code 2.¹⁰⁶ In addition, documents from 2008 indicate that Handling Code 2 could be used for entries made under “exigent circumstances which require immediate entry of the record.”¹⁰⁷ The full text of Handling Code 2 is as follows:

LAW ENFORCEMENT SENSITIVE INFORMATION

WARNING – APPROACH WITH CAUTION.

THIS INDIVIDUAL IS OF INVESTIGATIVE INTEREST TO LAW ENFORCEMENT REGARDING ASSOCIATION WITH TERRORISM AND THERE MAY BE A DETAINER AVAILABLE FROM THE DEPARTMENT OF HOMELAND SECURITY FOR THIS INDIVIDUAL.

IMMEDIATELY CONTACT THE TERRORIST SCREENING CENTER (TSC) AT (866) XXX-XXXX OR, IF YOU ARE A BORDER PATROL OFFICER, IMMEDIATELY CALL THE NTC TO ASCERTAIN IF A DETAINER IS AVAILABLE FOR THE INDIVIDUAL AND TO OBTAIN ADDITIONAL DIRECTION. PLEASE QUESTION THIS INDIVIDUAL TO ASSIST THE TSC IN DETERMINING WHETHER THE INDIVIDUAL ENCOUNTERED IS THE SUBJECT OF A DETAINER WITHOUT OTHERWISE EXTENDING THE SCOPE OR DURATION OF THE ENCOUNTER.

UNAUTHORIZED DISCLOSURE OF TERRORIST WATCHLIST INFORMATION IS PROHIBITED. DO NOT ADVISE THIS INDIVIDUAL THAT THEY MAY BE ON A TERRORIST WATCHLIST. INFORMATION THAT THIS INDIVIDUAL MAY BE ON A TERRORIST WATCHLIST IS PROPERTY OF THE TSC AND IS A FEDERAL RECORD PROVIDED TO YOUR AGENCY THAT MAY NOT BE DISSEMINATED OR USED IN ANY PROCEEDING WITHOUT THE ADVANCE AUTHORIZATION OF THE TSC.

LAW ENFORCEMENT SENSITIVE INFORMATION¹⁰⁸

As the above language indicates, the querying officer is instructed to “question this individual” in order to help the NTC to determine whether this person is subject to a detainer, but the message provides no guidance on the questioning or the kind of information that would assist in such a determination. It also appears doubtful that officers could question an individual “without otherwise extending the scope or duration of the encounter,” since presumably an encounter with an individual not listed in VGTOF/KST would not involve additional questioning or awaiting a reply from the TSC or the NTC. Thus, encounters with individuals subject to Handling Code 2 will likely be longer and more

¹⁰⁵ Communications from Counterterrorism to All Field Offices and All Legats, Re: Counterterrorism Program Guidance/Watchlisting/Administrative and Operational Guidance (Dec. 7, 2009), http://epic.org/privacy/airtravel/EPIC_DOJ_FOIA_NoFlyList_09_13_11_CT_Guidance2.pdf, ¶ 1.2.1.1.

¹⁰⁶ *Id.* ¶ 1.6.

¹⁰⁷ STANDARD OPERATING PROCEDURES: NOMINATION PROCESS, TERRORIST SCREENING CENTER NOMINATIONS AND DATA INTEGRITY UNIT (Aug. 2, 2006), No. NCIC-VGTOF-8403.

¹⁰⁸ 2009 NCIC Operating Manual, *supra* note 49, No. NCIC-VGTOF-709.

intrusive than they otherwise would because of the ambiguity of the instructions and the directive to officers to question the individuals further.

Finally, Handling Code 3 applies to all entries that are not categorized as Handling Code 1, Handling Code 2, or silent hits.¹⁰⁹ The text of the message for Handling Code 3 states:

LAW ENFORCEMENT SENSITIVE INFORMATION

DO NOT ADVISE THIS INDIVIDUAL THAT THEY MAY BE ON A TERRORIST WATCHLIST. CONTACT THE TERRORIST SCREENING CENTER (TSC) AT (866) XXX-XXXX DURING THIS ENCOUNTER. IF THIS WOULD EXTEND THE SCOPE OR DURATION OF THE ENCOUNTER CONTACT THE TSC IMMEDIATELY THEREAFTER. IF YOU ARE A BORDER PATROL OFFICER IMMEDIATELY CALL THE NTC.

ATTEMPT TO OBTAIN SUFFICIENT IDENTIFYING INFORMATION DURING THE ENCOUNTER, WITHOUT OTHERWISE EXTENDING THE SCOPE OR DURATION OF THE ENCOUNTER, TO ASSIST THE TSC IN DETERMINING WHETHER OR NOT THE NAME OR IDENTIFIER(S) YOU QUERIED BELONGS TO AN INDIVIDUAL IDENTIFIED AS HAVING POSSIBLE TIES WITH TERRORISM.

DO NOT DETAIN OR ARREST THIS INDIVIDUAL UNLESS THERE IS EVIDENCE OF A VIOLATION OF FEDERAL, STATE OR LOCAL STATUTES.

UNAUTHORIZED DISCLOSURE IS PROHIBITED.

INFORMATION THAT THIS INDIVIDUAL MAY BE ON A TERRORIST WATCHLIST IS PROPERTY OF THE TSC AND IS A FEDERAL RECORD PROVIDED TO YOUR AGENCY THAT MAY NOT BE DISSEMINATED OR USED IN ANY PROCEEDING WITHOUT THE ADVANCE AUTHORIZATION OF THE TSC.

WARNING – APPROACH WITH CAUTION.

LAW ENFORCEMENT SENSITIVE INFORMATION¹¹⁰

¹⁰⁹ STANDARD OPERATING PROCEDURES: NOMINATION PROCESS, TERRORIST SCREENING CENTER NOMINATIONS AND DATA INTEGRITY UNIT (Aug. 2, 2006), No. NCIC-VGTOF-8374. In the past, there was an additional Handling Code 4 containing less biographical information than Handling Code 3, requiring only a name and an “incomplete” date of birth. *Id.*; see Communications from Counterterrorism to CJIS, Re: Terrorist Screening Database; Violent Gang and Terrorist Organization File (VGTOF) – Handling Code 4 to 3 Conversion (June 14, 2004), No. NCIC-VGTOF-10908; FBI Email, Subject: HC 4 to 3 Conversion (June 16, 2005), No. NCIC-VGTOF-10912 to NCIC-VGTOF-10913. As of early 2004, Handling Code 3 was also the default code for the subjects of preliminary investigation. Communications from Counterterrorism to All Field Offices, Re: Violent Gang and Terrorist Organization File (VGTOF), No. NCIC-VGTOF-10871.

¹¹⁰ 2009 NCIC Operating Manual, *supra* note 49, No. NCIC-VGTOF-709.

This message makes clear that the querying officer should attempt to identify, but not to arrest or detain, the individual; it also states that the officer may contact the TSC after letting the individual go to avoid extending the length of the encounter.

The three handling codes above were in operation as of 2009, but it is not clear if they continue to contain the language and format as listed above. In the past, some handling code messages contained a stronger warning against using the VGTOF hit as grounds for search and seizure:

WARNING – STANDING ALONE, NCIC VIOLENT GANG AND TERRORIST ORGANIZATION FILE INFORMATION DOES NOT FURNISH GROUNDS FOR THE SEARCH AND SEIZURE OF ANY INDIVIDUAL, VEHICLE, OR DWELLING¹¹¹

This warning appears to have been omitted from the most recent handling codes; the 2009 handling codes lack such specific instructions for law enforcement to ensure that they do not use KST hits improperly to extend the scope of detentions.

The documents related to encounters with watchlisted people underscore that KST functions primarily as a means of tracking and monitoring individuals about whom the FBI is suspicious. It is not aimed only at a legitimate and targeted need to apprehend actual, known terrorists, and it carries the significant risk that innocent people will be subjected to intense scrutiny or lengthy, intrusive stops by law enforcement officers.

¹¹¹ NCIC 2000 Operating Manual: Violent Gang and Terrorist Organization (VGTOF) File (Dec. 1999) ¶ 13.1. In addition, for some time after September 11, 2001, another handling code that specifically identified individuals as a potential suspects in the September 11 attacks:

WARNING - INDIVIDUAL MAY BE SOUGHT BY FBI FOR QUESTIONING RELATED TO ATTACKS AGAINST WORLD TRADE CENTER AND PENTAGON. APPROACH WITH CAUTION. HOWEVER, MAKE NO EFFORT TO ARREST INDIVIDUAL UNLESS THERE IS EVIDENCE OF A VIOLATION OF FEDERAL, STATE, OR LOCAL STATUTE(S). RATHER, LAW ENFORCEMENT OFFICERS ARE REQUESTED TO STOP AND PROACTIVELY QUESTION THESE INDIVIDUALS AND TO CONTACT THE NEAREST FBI OFFICE IMMEDIATELY FOR FURTHER GUIDANCE. THESE INDIVIDUALS MAY BE HELPFUL IN PROVIDING INFORMATION AND POSSIBLY EVIDENCE IN SUPPORT OF AN ONGOING INVESTIGATION. SEE CURRENT FBI NLETS MESSAGE BOLO FOR MORE INFORMATION.

No. NCIC-VGTOF-11586.

V. SILENT HITS

The ACLU's FOIA litigation revealed for the first time the widespread and growing use of "silent hits," a mechanism through which the FBI can keep tabs on individuals suspected of terrorism without notifying either those individuals or the local law enforcement officers who encounter them:

- Silent hit entries allow the FBI and other executive departments and agencies to track watchlisted individuals while withholding this information from state and local law enforcement officials who encounter the individuals. Whenever local law enforcement encounters an individual with a silent hit entry, the FBI (and sometimes other designated agencies) will be automatically notified, but the local law enforcement officer will not.
- The use of silent hits has grown over time, and more agencies have gained the ability to "nominate" individuals for silent hits as well as receive notifications of encounters.
- Because of their highly secret nature, silent hit nominations are subject to less procedural protection, and it is extremely difficult for individuals wrongly placed on the list to seek redress.

A. Criteria for Silent Hit Nominations

The VGTOF/KST watchlist allows some individuals to be tracked without even the awareness of local law enforcement. When a local law enforcement officer encounters an individual with a silent hit entry and sends a query through the NCIC, the officer receives no hit in response, as if no record existed. Simultaneously, however, a notification is sent to the FBI or another nominating agency, informing them that the individual has been encountered.

A directive from the Counterterrorism Division to all FBI field offices in July 2006 stated that the subjects may be nominated as a silent hit entry in circumstances where the nominating official can articulate "a specific, narrowly-defined and legitimate operational justification" for requesting the silent hit.¹¹² Such justifications include the following:

- 1) "Subject of investigation is the target of 24/7 physical surveillance, undercover activities and operations, and undisclosed participation in organizations, in conformity with FBI policy";

¹¹² Communications from Counterterrorism Division to All Field Offices (July 25, 2006), No. NCIC-VGTOF-10889.

- 2) “Subject is an employee, member, or is affiliated with a military, federal, state, local, or other law enforcement agency, or any group that may have access to NCIC terminals”; or
- 3) “Other unique operational circumstances in which a nominating official can articulate a reasonable and detailed justification why the subject should be included in NCIC/VGTOF as a silent hit.”¹¹³

A proviso in the same directive recognized that because the fact that encountering officers are not alerted to silent hit entries “raises officer safety issues, subjects who have a violent nature or are known to be armed and dangerous should not be marked as silent hits.”¹¹⁴

In order to ensure that those considered “armed and dangerous” are not listed as silent hits, internal guidelines from May 2008 stated that the “Officer Safety Information Field” of an individual’s VGTOF entry must “be null/blank for records with a HC [handling code] of R or S.”¹¹⁵ The “Officer Safety Information Field” includes any information “that would serve to protect or support an encountering law enforcement officer,” including that the subject “professes to kill or harm law enforcement,” “is known to impersonate a law enforcement officer,” “has been issued a concealed weapons permit,” or “is known to carry weapons on his person.”¹¹⁶ Correspondingly, the guidelines stated that “it is imperative that individuals that pose any degree of threat to the safety of an encountering law enforcement officer not be issued a Silent Hit Handling Code.”

B. Expanding Use

The records the ACLU obtained through FOIA indicate that the capability to utilize silent hits was originally intended to be temporary.¹¹⁷ Only CJIS could enter silent hit entries, and a local law enforcement officer’s query of a silent hit record prompted a notification only to FBI Headquarters.¹¹⁸ Around February 2002, silent hits became a permanent fixture of the system, and the “Office of Origin” for a particular case gained the ability to receive notifications regarding that silent hit record.¹¹⁹

¹¹³ *Id.*

¹¹⁴ *Id.*

¹¹⁵ New FBI Nomination Processing Protocol (May 5, 2008), No. NCIC-VGTOF-10558. “R” stands for “routine” and “S” stands for “sensitive” silent hits. FBI NOMINATIONS & VGTOF TRAINING, No. NCIC-VGTOF-8345, *supra* note 13. Although the criteria for these is not clear, there is “no operational difference” between the two handling codes. *Id.*

¹¹⁶ New FBI Nomination Processing Protocol (May 5, 2008), No. NCIC-VGTOF-10559.

¹¹⁷ Communications from Counterterrorism Division to All Field Offices (Feb. 22, 2002), No. NCIC-VGTOF-11121.

¹¹⁸ *Id.*

¹¹⁹ *Id.*

As of 2008, the FBI and “OGAs” (likely “other government agencies”) could nominate individuals to be included as silent hit entries and receive notifications from encounters with those individuals.¹²⁰ In some circumstances, “sole OGA identities” with “no FBI nexus/interest” could also be included as silent hit entries.¹²¹ It is unclear whether and to what extent the FBI reviewed silent hit nominations from outside agencies before approving them.

Total Silent Hit Records

The use of silent hits grew dramatically after their inception, from several hundred records in early 2003 to over 4,600 records by mid-2006 (see Figure 11). In the period from 2004 to 2008, silent hit records consistently made up between 1 to 3 percent of all records in the VGTOF database.

Figure 11. *Total Silent Hit Records*¹²²

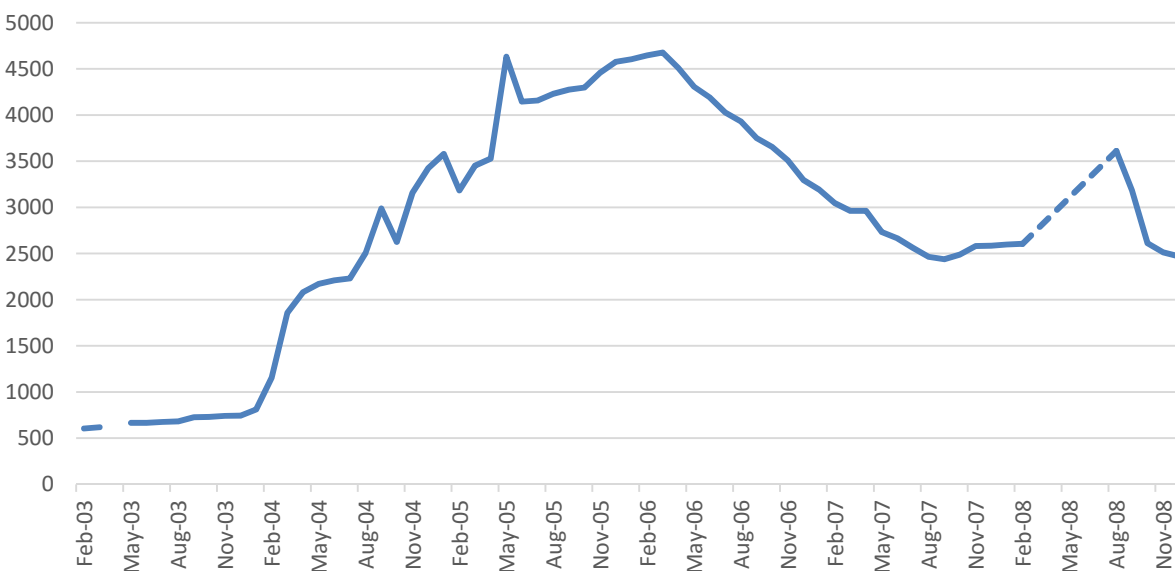

¹²⁰ *Id.* Silent hit entries may also be accessible through the National Instant Criminal Background system (NICS), the database used by federal firearms licensees to determine whether individuals are eligible to buy firearms or explosives. From April to May 2004, NICS received routine silent hit records within an inquiry hit response. After May 2004, sensitive silent hits were restricted in response to NICS queries, but routine silent hit records may still be received through NICS. Terrorist Screening Center Initiative Summaries and associated [sic] Specification Documentation Change Requests (SDCR’s) and Program Tracking Reports (PTR’s) (May 26, 2004), No. NCIC-VGTOF-11207.

¹²¹ New FBI Nomination Processing Protocol (May 5, 2008), No. NCIC-VGTOF-10556.

¹²² The increase in February 2004 appears to be the result of a database change that relocated all “Terrorist Member/Silent Hit records from the Undercover database to the VGTOF database.” Terrorist Screening Center Initiative Summaries and associated [sic] Specification Documentation Change Requests (SDCR’s) and Program Tracking Reports (PTR’s) (May 26, 2004), No. NCIC-VGTOF-11207.

International versus Domestic Silent Hits

In terms of total numbers, the vast majority of silent hit records are international (see Figure 12). However, silent hit entries account for a much larger proportion of domestic entries than of international entries. In the period from 2005 to 2008, between 21.0 and 25.4 percent of domestic entries were silent hit entries, compared to between 1.0 and 2.4 percent of international entries.

Figure 12. International versus Domestic Silent Hit Records



C. Fewer Procedural Protections

Because silent hits are kept secret even from local law enforcement, they present an additional layer of due process concerns. First, silent hits undergo less review internally. Regular, non-silent hit subjects are required to be referred to the Office of the General Counsel and the Inspection Division of the FBI as a potential matter for Intelligence Oversight Board (IOB) review when the subject remains in the VGTOF/KST database after the FBI investigation is closed and is nominated solely by the FBI. Silent hits, on the other hand, “are not considered potential IOBs” and are not referred for such review.¹²³

Second, it is nearly impossible for an individual to challenge or seek redress for erroneous placement on the silent hit list. Generally, the government does not disclose whether an individual is on a terrorist watchlist. Nevertheless, in some instances, individuals who are

¹²³ Communications from Counterterrorism to All Field Offices (July 14, 2008), No. NCIC-VGTOF-10880.

designated as regular (i.e., non-silent) hits in VGTOF/KST have become aware of their likely inclusion on the watchlist through encounters with law enforcement, allowing them to at least file complaints for redress.¹²⁴ By contrast, individuals who are the subjects of silent hit entries have no way of knowing that they are watchlisted, making any challenge to their watchlist status highly unlikely.

VI. REDRESS

Obtaining redress for erroneous inclusion on VGTOF/KST is extremely difficult:

- The government does not confirm whether individuals who suspect that they have been adversely affected by placement on a watchlist are, in fact, watchlisted.¹²⁵
- The procedure for challenging erroneous inclusion on the terrorist watchlist is opaque, one-sided, and non-participatory.
 - Individuals can submit complaints only if they come to suspect, through encounters with law enforcement officers or other government officials, that they are included on the watchlist.
 - Individuals cannot review or refute any information underlying their placement on the watchlist.
 - Individuals are not granted a hearing at which they could establish their credibility before a neutral decision maker.
 - Individuals never receive a confirmation that erroneous information has been removed from watchlist-related files.

Until 2005, the government had no redress process in place for individuals who were erroneously placed on the watchlist.¹²⁶ In January 2005, the TSC established a formal redress procedure through which screening agencies could refer individual complaints to the TSC.¹²⁷ In

¹²⁴ See the discussion in Section VI on obtaining redress.

¹²⁵ The only exception to this policy resulted from litigation challenging the No Fly List redress procedure, which a federal court found unconstitutional in June 2014. *See* *Latif v. Holder*, 28 F. Supp. 3d 1134 (D. Or. 2014). Under the government's revised policy, instituted in April 2015, a U.S. person who purchases a ticket, is denied boarding at the airport, subsequently applies for redress through the Department of Homeland Security's Traveler Redress Inquiry Program, and is on the No Fly List after a redress review, will receive a letter disclosing that status on the No Fly List. If the individual opts to receive and/or submit further information, the government will provide a second response that includes an unclassified summary of reasons (of varying specificity and length) for the individual's inclusion on the No Fly List. *See* Notice Regarding Revisions to DHS TRIP Procedures, *Latif v. Holder*, No. 10-750-BR, ECF No. 197 (D. Or. Apr. 13, 2015). The plaintiffs in *Latif* have also challenged the revised redress process as inadequate under the Due Process Clause.

¹²⁶ 2007 OIG REPORT, *supra* note 19, at 45.

¹²⁷ 2013 WATCHLISTING GUIDANCE ¶ 1.67.

September 2007, agencies involved in the watchlist process executed a “Redress Memorandum of Understanding” to coordinate a redress process.¹²⁸

When an individual files a redress complaint, the screening agency—the agency that conducted the terrorist screening, for example airport security—forwards the complaint to the TSC.¹²⁹ TSC’s Redress Office then determines whether the complaint is related to a TSDB record, including whether the complainant is a watchlisted individual or “merely a near-match to a watchlist record.”¹³⁰ If the complainant is the watchlisted individual, TSC’s Redress Office coordinates with the nominating agency in determining whether the individual continues to meet the standards for remaining on the watchlist, and it can remove or modify the watchlist entry accordingly. The TSC has the final say on redress disposition.¹³¹ The screening agency sends a formal response to the complainant.¹³² An individual could try to file an administrative appeal through the screening agency where the agency makes such appeals available.¹³³ The TSC may then release or update the watchlist information. It is unclear if anyone has appealed a redress disposition successfully.¹³⁴

As of February 2007, it took the TSC an average of over two months to review a redress inquiry, and 28 percent of reviews lasted more than 90 days.¹³⁵ The TSC did not have explicit guidelines for timeliness in redress procedures as of that date.¹³⁶

The Department of Homeland Security’s Traveler Redress Inquiry Program (DHS TRIP) addresses redress complaints related to watchlist issues that arise during travel screening, including airport screening by the Transportation Security Administration and border screening conducted by Customs and Border Protection.¹³⁷

CONCLUSION

This White Paper pieces together previously unknown details about the federal government’s VGTOF/KST watchlist by synthesizing public materials and FOIA documents obtained from the FBI. However, because the FOIA documents are not comprehensive and only provide information until 2009, a number of informational gaps remain. For example, the

¹²⁸ *Id.* ¶ 1.68.

¹²⁹ *Id.* ¶ 1.67.

¹³⁰ *Id.* ¶ 1.69.

¹³¹ 2007 OIG REPORT, *supra* note 19, at 51.

¹³² *Id.*

¹³³ *Id.* at 57.

¹³⁴ *Id.*

¹³⁵ *Id.* at 54.

¹³⁶ *Id.* at 55-56.

¹³⁷ 2013 WATCHLISTING GUIDANCE ¶ 1.71.

documents do not reveal the extent to which VGTOF/KST information can be accessed by non-law enforcement agencies at the state level or even certain private entities, which could impact everything from bail determinations and sentencing to employment prospects and access to the financial system. It is also unclear what criteria and procedures other agencies follow in nominating subjects, and how rigorously those agencies review nominations or redress complaints. Similarly, we do not know which agencies can nominate individuals for silent hit entries and what standard of review is used to vet them.

Despite these knowledge gaps, the available information on the VGTOF/KST watchlist system leads to troubling conclusions. The system poses a serious threat to constitutional rights and civil liberties, as watchlisted individuals may be subject to unwarranted monitoring and surveillance, prolonged detention and questioning, and the stigmatization that comes with such law enforcement scrutiny. In addition, watchlisted individuals face the risk of mistaken dissemination of terrorist watchlist information to private third parties like employers and insurance companies.¹³⁸ They may also face discrimination in immigration and naturalization proceedings.¹³⁹ Despite the threat to these individuals' due process and privacy rights, they have little recourse to challenge the watchlisting procedures.

ACKNOWLEDGMENTS

The Civil Liberties and National Security Clinic at Yale Law School prepared this report on behalf of the American Civil Liberties Union.¹⁴⁰ Alice A. Wang and Angela Cai authored this report and Zachary Blau provided editorial assistance under the supervision of Michael J. Wishnie, William O. Douglas Clinical Professor of Law. The report was reviewed and edited by Lee Gelernt, Dror Ladin, Hugh Handeyside, and Hina Shamsi of the ACLU and by Kate Desormeau, formerly of the ACLU.

¹³⁸ The FOIA documents revealed numerous instances of unauthorized dissemination, often by mistake, including to insurance companies and private citizens. *See* No. NCIC-VGTOF-11494 to NCIC-VGTOF-11543.

¹³⁹ The Controlled Application Review and Resolution Program (CARRP) implemented by the United States Citizenship and Immigration Services (USCIS), for example, blacklists applicants who are in the KST database as “national security concerns” and denies them immigration benefits. MUSLIMS NEED NOT APPLY: HOW USCIS SECRETLY MANDATES THE DISCRIMINATORY DELAY AND DENIAL OF CITIZENSHIP AND IMMIGRATION BENEFITS TO ASPIRING AMERICANS, AM. CIVIL LIBERTIES UNION OF S. CAL. 17-18, <https://www.aclusocal.org/CARRP>.

¹⁴⁰ This paper reflects the views of its authors and the organizations that are publishing it. It does not represent the views of Yale Law School.



ADVOCACY FOR HUMANKIND

Testimonies of Coordinated Stalking by Multiple Persons from California Residents and Former California Residents

Testimonies of 90 persons include:

- Results of reporting the crimes to law enforcement
- Results from visits to mental health professionals
- Net results on victim's lives as a result of the crimes

Date: 7/17/19

Your Full Name: [REDACTED]

City: San Francisco

Zip Code: 94103

Please write a brief summary of your experience with coordinated stalking only:

I'm systematically subjected to organized stalking, surveillance and harassment by people in my neighborhood and countless individuals whenever I leave my home. I am followed on the streets, to stores, parks, restaurants, public restrooms, doctor appointments, and every other place I go to. I was under surveillance and bullied at three different places of employment. I am also stalked by perpetrators in vehicles. Tracking appears to be accomplished with the help of devices the perpetrators carry in backpacks, by watching, and use of cell phones which they always have in hand and often point in my direction. When going places I looked up online or mentioned in a phone conversation, there will be people standing around that place when I arrive, all looking directly at me, with cellphones in hand. If I'm walking into a building, two to three of those waiting, will walk in with me. These perpetrators often make eye contact to let me know I'm being watched. I have constant interference with normal flow of daily life, making almost every task difficult or impossible. Perpetrators can access all of my online communication, bank and credit card statements, my online medical record, pharmacy prescriptions, cell phone texts, and listen to all conversations. I have frequent problems with electronics, internet, and cable. I cancelled my Facebook account because of online bullying. I've had break-ins with personal belongings misplaced or items planted. All of this causes me to feel acute stress. I was diagnosed with PTSD.

Please describe your experience if/when you reported the crimes to law enforcement.

I didn't file a police report.

Please describe your experience of being misdiagnosed by mental health professionals if applicable:

I was misdiagnosed as being delusional, paranoid, bipolar disorder, schizoaffective disorder, and as being hyper-vigilant. Taking psychotropic medications hasn't made a difference. I continued to experience organized stalking. Being organized stalked at my job and outside of it, took it's toll on me and I was fired after missing too many days at work. I subsequently moved to Florida in 2011 to stay with my sister. I experienced some organized stalking while I was in Florida, as well. My organized stalking resumed when I moved back to San Francisco, four months later

Please briefly describe the resulting effects upon your life:

Because of surveillance, coordinated stalking and electronic hacking, I don't go outside alone. I stayed indoors for two years, with the exception of doctor appointments. I've accumulated debt as a result of long-term unemployment, and have financial hardship. I feel I've completely lost my freedom and privacy. I don't have a normal social life and feel very isolated.

Date: 08/06/2019

First Name: [REDACTED]

Last Name: [REDACTED]

City: Jacksonville

US States: CA

Zip: 28540

Have you experienced coordinated stalking?

I have been stalked and manipulated in a coordinated fashion by persons unknown to me. They have used drugging, psychological tactics, and violent methods:, busted fuse boxes via hit and run, breaking and entering, harassment, constant photos of my person for no reason, indirect and odd comments.

Have you reported coordinated stalking to law enforcement?

I've reported this to the FBI multiple times, the CIA, crime stoppers, Interpol, the police and crisis centers. None of which had done anything yet.

Have you been mis-diagnosed by mental health professionals?

I was forced into a mental health rehab for a week for no reason (I was feeling ill) and still diagnosed as fine and sane once I left the rehab. I have a whole notebook of misdiagnoses.

Resulting effects on your life:

Poor quality of life, loss of jobs, abuse, loss of belongings, friends, estranged family. Loss of finances, etc.

Date: 08/07/2019

First Name: [REDACTED]

Last Name: [REDACTED]

City: Santa Clarita

US States: CA

Zip: 91350

Have you experienced coordinated stalking?

Yes, I have been stalked and harassed by public who attempt to police my speech. I have been harassed to keep me in a negative, depressed state and have been attacked on a highway.

Have you reported coordinated stalking to law enforcement?

I have submitted a tip to FBI.

Have you been mis-diagnosed by mental health professionals?

Yes.

Resulting effects on your life:

It has destroyed my life, made me isolated and depressed with no financial security.

Date: 08/07/2019

First Name: [REDACTED]

Last Name: [REDACTED]

City: Oakley

US States: CA

Zip: 94561

Have you experienced coordinated stalking?

I have experienced coordinated stalking as a citizen living in California. It took me a long time to figure out what was going on in my life and why I kept having these bizarre experiences with people in my local area.

As a female, it has been terrorizing and has made living a daily life a constant concern. There were people around the town whom I did not know, but they knew all about me. They would say things to me only someone who knew me would know. They would follow me when I went to work, home, school, or anywhere else. I finally could not take anymore and moved out of the area. The harassment stopped temporarily, but started up again after a few months at the new location.

Have you reported coordinated stalking to law enforcement?

I alerted law enforcement to the situation and was told that since I did not show any signs of being harassed, stalked or physically injured, that maybe I didn't really have a problem.

This was with the police department in the City of Martinez several different times in 2015-2017.

The officers that I spoke with were doubtful that what I was saying was actually happening. I had to call them several times after finding people on my property that I did not know. They would come out or I would have to go down to the police department to file a report.

If a victim doesn't have proof of credible threat of violence or doesn't know the names of the parties involved in organized stalking, the court will not approve a restraining order. The language in the temporary restraining order describing prohibited behavior is clear and it is the same behavior that is going on in organized stalking.

My experience through the courts regarding temporary restraining orders, domestic violence vs civil harassment, showed me the areas of the law that do not protect the victims. In a civil harassment restraining order, there is a requirement to show a credible threat of violence.

Have you been mis-diagnosed by mental health professionals?

I did not seek assistance from a mental health professional. The experiences I had with local law enforcement was enough to show me that it would not be in my best interest to seek any kind of assistance.

Resulting effects on your life:

Organized stalking has changed my life tremendously. I no longer live freely or feel safe. I have had so much stress over this. It has caused me problems at work, where I live and with my family and friends. For a long time, I think my family and friends thought I was losing my mind. I have experienced stalking before in a domestic violence situation years ago, and in my opinion, organized stalking produces the same negative PTSD symptoms.

As a victim of this type of harassment, I can tell you that the damage this type of behavior has on a person is devastating. You feel like you cannot trust anyone. You feel isolated and targeted. You look to law enforcement and professionals and are told they cannot help you if you don't know who these people are or you do not have proof of the harassment.

A campaign is needed to enlighten law enforcement officers to this type of organized stalking and a law needs to be put forth to protect the victims this is happening to. No one deserves to go through this type of harassment. I no longer can live alone, I am afraid. I no longer take any trips by myself. I stopped driving in town. This type of stalking scared me to the very core and I still have a hard time being out in public, in crowds, or even out at the store. It is so stressful and intimidating, and must stop immediately.

Date: 07/20/2019

First Name [REDACTED]

Last Name [REDACTED]

City: Millbrae

US States: CA

Zip: 94030-2917

Have you experienced coordinated stalking?

The stalking started slowly with just a couple of men. They watched me constantly, followed me to restaurants, but did not order food. Followed me in daily activities, e.g., grocery stores, pharmacies, medical appointments, 3-day stay in hospital.

In 2014, the stalking got much more intense with many people overtly following me, blocking my entry/exit from work and home and everywhere I traveled daily. Some covered their license plates or removed their plates. Many used personalized license plates with my nickname [REDACTED]. Subsequently, the same vehicle would follow me, with the same driver and with what appeared to be the same car with a different, switched license plate.

Have you reported coordinated stalking to law enforcement?

EVENT ONE: In 2018, I reported the stalking to Burlingame police Dept. An officer came to my office and chastised me for calling him. I told the officer that one of my stalkers was a tenant who drove a limo, whose office was in my building. The suspect would block my entry into the parking lot. He also drove a vehicle without plates. He followed me constantly. The officer did not investigate anything.

EVENT TWO: In 2018, I reported a second stalking by another tenant in my building. The suspect followed me when I went to lunch, blocked and followed me when I got off work. The Burlingame Police officer scolded me and offered to take me to a mental ward and be admitted into a hospital. He asked me for my husband's phone number and called him. The officer told my husband "to take care of the matter" but the officer did not tell my husband what 'the matter' was. My husband was very upset and frightened. I did not receive due process in either situation. I was treated in a misogynist, hateful manner.

The automobile vandalism started in 2016.

In February 2016, I had a slice in a tire. \$350

In April 2016, a "keyed" door on passenger side \$2500

In November 2016, another keyed door on driver side. \$2500

In January 2017, a deliberate hit and run by a driver with a dealer plate. Over \$4,000 damage.

In March 2017, an item thrown in road causing damage by hateful driver. Over \$5,000 damage

In July 2017, a scratched door, causing \$1500 damage

In October 2017, a cracked windshield \$250 damage.

In January 2, 2018, 3 nails in my tire. I bought a Model 3 that same day. The car was vandalized at the Tesla dealership parking lot. \$400 damage

In March 2018, a car hood thrown in road causing damage \$4,000.

In June 2018, a punctured tire. \$400

In July 2018, stolen hose from pool house \$20.

In January 2019, another punctured tire \$400.

In June 2019, a car part thrown in road causing \$4,000 damage.

In July 2019, a puncture in tire causing \$400 damage

In August 2019, a chemical poured on windshield causing damage \$50 in cleaning chemicals to get it out.

In August 2019, another chemical poured on rear glass - \$0 damage – rubbed it out. *(cont'd)*

Have you been mis-diagnosed by mental health professionals?

No.

Resulting effects on your life:

As a result of the stalkers in my building in Burlingame, where my office is located, I do not work there on a daily basis. I moved my work to my Home Office in Millbrae. I do not socialize because of the interference and false accusations. I have become more reclusive and stay home. I do as much as possible from my Home Office.

Date: 08/07/2019

First Name: [REDACTED]

Last Name: [REDACTED]

City: San Francisco

US States: CA

Zip: 94124

Have you experienced coordinated stalking?

I am being stalked at my work and in my community. Nude photos of me have been uploaded on random electronic devices such as cpu's, laptops, and cell phones to slander, discredit, and harass me. They sent nude photos of me to random mobile phones, including my daughter's. There have been break-ins at my living quarters with property destroyed, rearranged, but nothing stolen. A stranger came to my home, rang my doorbell and shot at me, my son and wife when we answered the door.

They made up a profile of me slandering me and discrediting me in society. Not only has it occurred in my community, but also in my place of work with my coworkers. I am labeled a sex offender when I've NEVER been charged or incarcerated with those offenses. There's noise campaign in front of my house with random vehicles revving their loud engines or honking their horns in front of my home.

Have you reported coordinated stalking to law enforcement?

Yes. To both local law enforcement and FBI

Have you been mis-diagnosed by mental health professionals?

I went to the hospital for a wellness check, and was diagnosed as paranoid and schizophrenic

Resulting effects on your life:

It has caused me severe stress, PTSD, and I was driven to homelessness. I've been blacklisted and as a result, have not been able to find work.

Date: 08/06/2019

First Name: [REDACTED]

Last Name: [REDACTED]

City: Trona

US States: CA

Zip: 93562

Have you experienced coordinated stalking?

I have experienced coordinated stalking at my home, on my way to my family's home in Missouri, at my friends' homes, at grocery stores, and my favorite bar. I was stalked on my way to and from Arizona. I experience this 24 hrs, 7 days a week. I cannot go anywhere without this coordinated Stalking occurring.

Have you reported coordinated stalking to law enforcement?

I have not contacted the Police or any other Agencies. Police were first to make contact with me, and I knew better than to file a complaint with them.

Have you been mis-diagnosed by mental health professionals?

I have not been diagnosed.

Resulting effects on your life:

As a result, I have a hard time trusting people. The bottom line is because of this Coordinated Stalking, my life will never be the same.

Date: 08/06/2019

First Name: [REDACTED]

Last Name: [REDACTED]

City: Santa Monica

US States: CA

Zip: 90405

Have you experienced coordinated stalking?

I am being gang stalked on a daily basis, being “gassed” with chemical weapons (evidence available via saliva samples and hair samples) in my own apartment and on the streets of Santa Monica.

Have you reported coordinated stalking to law enforcement?

Yes, I filed numerous police reports and provided indisputable evidence to no avail.

Please tell us if you moved due to the stalking:

I have moved 5 times trying to escape these criminals. Please help!

Have you been mis-diagnosed by mental health professionals?

N/A

Resulting effects on your life:

It has destroyed my life. I am a prisoner in my own home. I’m trying to survive the best I can. These criminals must be stopped at all cost.

Date: 08/06/2019

First Name: [REDACTED]

Last Name: [REDACTED]

City: Palm Springs

US States: CA

Zip: 92264

Have you experienced coordinated stalking?

I experience intimidation, assaults, set-ups, and gaslighting. I am followed 24/7 and I'm constantly told that I'm a pedophile. I had threats made against my family and break-ins in my house until I was homeless.

On 1-12-18 I was set-up to unknowingly commit a crime and was arrested. I was told by a former neighbor and a fake friend that the only way for me to report the crime was to go outside the state. They lent me use a car and I drove to Arizona. I waited for the Sheriff to arrive and told him what was happening, but he ignored my complaint and arrested me instead because the car I drove was reported stolen. The sheriff told me that I was not [REDACTED] and on his report he falsely added that I was arrested before on marijuana charges. (I have his report)

I enforced my Miranda rights, but the organized stalking and harassment continued at La Paz Adult Detention Facility in Parker AZ. When I refused to sign any documents, they dragged me to a room while I was handcuffed, stripped me completely naked, threw me on the floor and assaulted me. I sustained bodily injuries and was placed in solitary confinement for three days. They refused me medical attention and I almost lost my leg. My case was abuse of due process under the color of law with malicious prosecution.

My case was dismissed on 5-9-19. When I got out on 5-29-18, the guard threatened me that if I do not sign the papers which I refused to sign at the beginning, he would not release me. They also conducted a search without my consent or knowledge and seized some of my property including evidence to prove my case in court. My public defender and prosecutor tried to declare me mentally incompetent to stand trial three times (rule 11) and each time the results were that I'm sufficiently competent to stand trial. I complained to the state bar and they were disciplined.

Have you reported coordinated stalking to law enforcement?

Every time I wanted to reported to Palm Springs Police Department, they would say the detective was busy and another officer would just ignore me. I contacted in person the assistant district attorney and she ignored me. When I got out of jail, I filed a complaint with government agencies and on September 2018 I was contacted by FBI special agent Michael Morgan from the Palm Springs office and opened an investigation. I tried to contact him about my case, but he told me that my case was transferred to the Phoenix office. I was not given a case number. The status of the case is unknown. The coordinated stalking has stopped since I spoke to FBI.

Have you been mis-diagnosed by mental health professionals?

No Never.

Resulting effects on your life:

They have destroyed my life and the life of my daughters for no reason, as I'm a great citizen. I have been homeless for 4 years now and I can't get a job. I now realize that the constitution, the bill of rights and the law are not for everyone, and there has been no justice. I'm traumatized, hurt, frustrated, and angry with the government because there is so much information about organized stalking, but there is no help for the victims.

Date: 08/06/2019

First Name: [REDACTED]

Last Name: [REDACTED]

City: Clovis

US States: CA

Zip: 93619

Have you experienced coordinated stalking?

Stalked by people in vehicles, even when travelling to other cities in California. Stalkers in vehicles with one headlight turned off in Eugene, OR.

Have you reported coordinated stalking to law enforcement?

I sent a letter to the Fresno FBI office and have reported it to their online tips over 20 times.

Have you been mis-diagnosed by mental health professionals?

Yes, I was diagnosed with Schizophrenia and my medication costs \$2,500 per month.

Resulting effects on your life:

Destroyed my ability to live a long life and prosper.

Date: 06/01/2019

First Name: [REDACTED]

Last Name: [REDACTED]

City: Chula Vista

US States: CA

Zip: 91910

Have you experienced coordinated stalking?

I am experiencing organized stalking. There is no place to go for help. We need a bill passed that protects us from these serious human rights abuses

Have you reported coordinated stalking to law enforcement?:

I contacted the Chula Vista police regarding this matter. I contacted Chula Vista City Council many times with information regarding this ongoing crime, but they ignored me. Finally, they tried to confine me in mental ward, so I stopped trying to get help from them.

Have you been mis-diagnosed by mental health professionals?:

Yes, I have been misdiagnosed with schizophrenia by the state of California and was forced to take harmful medication.

Resulting effects on your life:

The stalking has degraded my life in many ways. Financial, social, physical pretty much all aspects of my life have been degraded.

Date: 08/05/2019

First Name: [REDACTED]

Last Name: [REDACTED]

City: Lancaster

US States: CA

Zip: 93535

Have you experienced coordinated stalking?

Groups of drivers nearly cause traffic accidents on freeways, highways and roads. Being followed in stores, medical offices and pharmacy. My sister and I are surrounded by strangers in an aggressive manner to the point where we simply leave the store without purchasing our needed items.

Have you reported coordinated stalking to law enforcement?

8/5/19: [REDACTED] went to Palmdale CA sheriff regarding organized stalking and cell phone interception.

6/4/19: Lancaster CA sheriff. Tried to report people near our residence door (no police report taken).

Have you been mis-diagnosed by mental health professionals?

Myself ([REDACTED]) misdiagnosed by a Nurse Practitioner, Nicolette Alexander

Resulting effects on your life:

1. [REDACTED] end stage kidney failure
2. No assistance from law enforcement
3. Doctors say to go see a mental health doctor
4. If we lived alone we would be isolated
5. [REDACTED] is unable to get SSI payments. She is homeless and greatly struggles to cope with life.

Date: 08/05/2019
First Name: [REDACTED]
Last Name: [REDACTED]
City: Thousand Oaks
US States: CA
Zip: 91360

Have you experienced coordinated stalking?

I am a victim of organized stalking.

Have you reported coordinated stalking to law enforcement?

I have reported my experiences to various police officers. My last police report was in May 2019 at the Simi Valley police station.

Have you been mis-diagnosed by mental health professionals?

Yes, I have been diagnosed with schizoaffective disorder. I believe this to be completely false.

Resulting effects on your life:

This experience has been catastrophic and devastating. I can barely make a living compared to being extremely successful 10 years ago.

Date: 08/08/2019

First Name: [REDACTED]

Last Name: [REDACTED]

City: San Pedro

US States: CA

Zip: 90731

Have you experienced coordinated stalking?

I have organized stalking everyday that I leave my house. They follow me in cars and on foot inside the stores that I go to, or if I take a walk. My phone is tapped.

Have you been mis-diagnosed by mental health professionals?

They tried to lock me up in a psych ward when I had physical symptoms. I was later placed on a psych hold three times when I tried to reach out to police, lawyers and doctors.

I've been labeled schizophrenic and now placed under mental health conservatorship where I'm forced to take medication. I am not a schizophrenic at all. This is psychological torture on a daily basis. They now have have me labeled mentally ill so I don't speak out and get the help that I deserve.

Date: 08/09/2019

First Name: [REDACTED]

Last Name: [REDACTED]

City: Tujunga

US States: CA

Zip: 91042

Have you experienced coordinated stalking?

Yes. Experience organized stalking at restaurants, Walmart, hospitals, streets, Greyhound, churches, etc.

Have you reported coordinated stalking to law enforcement?

FBI, Fire Department

Have you been mis-diagnosed by mental health professionals?

I have mild dyslexia so when stressed it effects my communications skills. Describing situation is used as a means of discrediting me.

Date: 08/08/2019

First Name: [REDACTED]

Last Name: [REDACTED]

City: Los Angeles

US States: CA

Zip: 91702

Have you experienced coordinated stalking?

Yes

Have you reported coordinated stalking to law enforcement?

Yes

Have you been mis-diagnosed by mental health professionals?

No

Resulting effects on your life:

My marriage has been destroyed.

Date: August 22, 2019

First Name: [REDACTED]

Last Name: [REDACTED]

City: Pacifica

State: CA

Zip code: 94044

Have you experienced coordinated stalking?

Yes. Coordinated stalking and harassment by multiple persons. Break-ins to home and car, whereby items are moved around. One time some clothing was cut with scissors. Another time a plastic juice bottle was left in my home (I don't drink juice) A pet was kidnapped from my home and tortured. Noise campaigns constantly, disturbing not only me, but all neighbors within a few blocks. This consists of: loud revving engines, the vehicles circling surrounding streets and particularly under my balcony; chronic barking dogs; leaf blowers and power tools; chronic hammering. It should be noted that this noise campaign escalates if I sit outside on my deck.

My last computer was hacked with perpetrators accessing it remotely. I have since bought a new computer, which I keep with me at all times. This with Spyware and VPN seems to have stopped the hacking or I am not aware of it. In-home surveillance has been prevalent. Multiple persons who I don't know mirror my home activities in public. Example: I do yoga most mornings. Stalkers in public will put themselves in my path and do poses that I did that morning. Many more examples available.

I experience road bullying on an ongoing basis. Several times have almost been driven off road.

Slander is also prevalent. This is obvious when people say things to me like the following: "you are a sick, sick, woman". "You are vile and disgusting". Implications made that I am a sociopath or psychopath. I have no idea what is being said to people about me and hence have no way to defend myself. This has caused the loss of at least 5 jobs and more social implications, i.e., ostracizing in many social circles and further harassment. Slander infiltrates workplace. People have tried to frame me at the workplace.

Framed: I was framed to appear that I had done credit card fraud. The allegation was that I stole a credit card from a housemate's mail, and then took the card to an ATM and withdrew the entire balance of \$300.00. I was never arrested because bank ATMs have cameras. I have never been to the bank where this supposedly happened.

Have you reported coordinated stalking to law enforcement?

I have not reported the entire phenomenon. However, somebody with a large tow truck parked it under my balcony (residential area) and would just rev the engine for hours, day after day. Emissions from the truck were so overwhelming that my home was immersed in fumes even with the door closed. I filed 6 reports with the Pacifica police. Truck usually left right after I would call the police. Finally the perpetrator stopped after several months of this. Of note is that I made a lot of videos of this truck and the police refused to view them.

Have you moved because of coordinated stalking?

Yes. Moved over 10 times trying to escape.

Have you been misdiagnosed by mental health professionals?

Yes

Resulting effects on your life:

Unable to keep a full time job due to slander, which creates workplace harassment and ostracizing. Before this I was a professional with my own corporation and had upper middle class income. All clients abandoned my business. Because of this was rendered homeless and also placed on 5150 hold when I had a crying spell at a shelter due to being overwhelmed by the entire situation. Never would I have thought I would be homeless in my life. Anxiety, some paranoia and ongoing PTSD. I now have an auto-immune disorder, which I think is directly due to the enormous stress from coordinated stalking. Tendency to isolate and social life has vanished. Friends either don't believe me or are frightened it will happen to them.

Date: 08/09/2019

First Name: [REDACTED]

Last Name: [REDACTED]

City: Nice

US States: CA

Zip: 95464

Have you experienced coordinated stalking?

Yes.

Have you reported coordinated stalking to law enforcement?

Yes. Reported organized stalking to the FBI and local police.

Have you been mis-diagnosed by mental health professionals?

Yes. Reported stalking to psychiatrists.

Resulting effects on your life:

The effects are horrific. I feel isolated, malaise and have PTSD.

Date: 08/10/2019

First Name: [REDACTED]

Last Name: [REDACTED]

City: San Bruno

US States: CA

Zip: 94066

Have you experienced coordinated stalking?

I started noticing I was being followed by random people on foot and in vehicles at the former condo complex I lived at, at work, in the streets, at stores, and etc.

Have you reported coordinated stalking to law enforcement?

No. I have not.

Have you been mis-diagnosed by mental health professionals?

I was hospitalized at Kaiser Permanente's Santa Clara behavioral hospital for informing the Kaiser psychiatric department in San Francisco that I was being stalked by strangers.

Resulting effects on your life:

I have lost my job of 10 years due to workplace stalking. I was forced to sell my home, my wife wants to divorce me, friends and relatives distancing themselves or treating me in a cold manner, and of course the mental trauma of being a targeted person.

Date: 08/10/2019

First Name: [REDACTED]

Last Name: [REDACTED]

City: Carson

US States: CA

Zip: 90745

Have you experienced coordinated stalking?:

One time two men were sitting in a red car, plain clothed, when I overheard them saying "Let's see where she goes." Once they knew my whereabouts & routine, from that they intercepted my letters to POTUS Trump. I saw them get out of a little car taking the letters out of the mailbox.

They even prevented me from going to the library. A plain clothed man met me at the door & said "[REDACTED] go home." In another incident, a man dressed in a work uniform was giving me a cold stare and was hanging out in the dining room at breakfast. He later got to my laundry, when I put it in. He had sliced my bra open with his knife. I know this because he was right there in the laundry room & offered to clean the vent with his knife, which he did. I discovered it later.

Resulting effects on your life:

I have 5 pages describing what they've done. This all serves to makes me feel like I have no privacy. I feel powerless despite what I've done about the situation politically. I have to go about cleaning up their messes or live with the results. So, it causes me depression, anxiety and insomnia.

Date: 08/11/2019

First Name: [REDACTED]

Last Name: [REDACTED]

US States: CA

Zip: 92065

Have you experienced coordinated stalking?

Yes I believe I have, but I have no proof.

Have you reported coordinated stalking to law enforcement?

Yes, and a highly religious mental health officer offered me hospitalization.

Have you been mis-diagnosed by mental health professionals?

Yes, I believe their goal was to pump me up full of medications.

Resulting effects on your life:

I cant keep a basic job or keep up at school. My body is swollen from the extra stress, I have lost IQ points, I am always angry because of the distractions that I can hear from earshot.

Date: 08/11/2019

First Name: [REDACTED]

Last Name: [REDACTED]

City: Poway

US States: CA

Zip: 92064

Have you experienced coordinated stalking?

Organized stalking is used against me, and stalkers use anything to demotivate and convince others I have mental health disorders.

Have you reported coordinated stalking to law enforcement?

In 2018, I reported stalkers, I was assumed to be hallucinating.

Have you been mis-diagnosed by mental health professionals?

Yes, my stress levels raised to where I needed to see a doctor. I was observed and prescribed antipsychotics . I was not given a brain scan.

Resulting effects on your life:

Everything is more difficult. I regrettably fantasize about suicide. Basic work is more difficult, school is more difficult, and my relationships are poor.

Date: 08/11/2019

First Name: [REDACTED]

Last Name: [REDACTED]

City: Duarte

US States: CA

Zip: 91010

Have you experienced coordinated stalking?

Yes

Have you reported coordinated stalking to law enforcement?

Only when I was arrested under the pretense of being a schizophrenic.

Have you been mis-diagnosed by mental health professionals?

Yes, I have been to many psychiatrists and medical doctors and have expressed to them my truth only to be doubted.

Resulting effects on your life:

I am highly educated and highly in debt for my education. I cannot work due to sleep deprivation and constant harassment. Not to mention being mentally exhausted. I have lost all that I worked for including 401k's, home and car.

Date: 08/11/2019

First Name: [REDACTED]

Last Name: [REDACTED]

City: Mission Viejo

US States: CA

Zip: 92691

Have you experienced coordinated stalking?

I was stalked everywhere I went. Stores and any place of business. I went out dancing with my boyfriend 3 nights per week. High end dinner and dancing. Also was always stalked there and even sat down with our group to try to bully me. When I got there, there they were. Even lunch at PM market. Always followed. Could not shop without being followed.

Have you reported coordinated stalking to law enforcement?

I did not report to police. I reported it online to FBI.

Have you been mis-diagnosed by mental health professionals

No

Resulting effects on your life:

Creates fear and affects all aspects of your life and difficult sleeping. Always looking over your shoulder and feeling hopeless at times.

Date: 08/11/2019

First Name: [REDACTED]

Last Name: [REDACTED]

City: Mission Viejo

US States: CA

Zip: 92691-3841

Have you experienced coordinated stalking?

Yes.

Have you reported coordinated stalking to law enforcement?:

No

Have you been mis-diagnosed by mental health professionals?

No

Date: 08/11/2019

First Name: [REDACTED]

Last Name: [REDACTED]

City: San Marcos

US States: CA

Zip: 92069

Have you experienced coordinated stalking?

At the beginning I thought it was random. The person would make eye contact when they identified me on the streets, then would leave immediately. I didn't know why. Then it became more suspicious when I traveled to other places, even out of the country and randomly would see the stalkers. They would only make a gesture of identifying me and leave. I've tried confronting them, but they denied it or avoid any confrontation, gaslighting me. It's come to the point of an invasion of privacy and harassing me.

Have you reported coordinated stalking to law enforcement?

In 2015 I made a report to the FBI about it. It was a forensic psychologist for the FBI and she was recording the conversation on her cell phone and just said that I need to go first to the sheriff's department first. She would make any notification about the coordinated stalking.

Have you been mis-diagnosed by mental health professionals?

Yes, I got medboarded (MEDICAL EVALUATION BOARD?) from the military as a paranoid schizophrenic, but at the same time I was made fun of for getting out of the military. I was forced to take medication even when I asked and argued that this wasn't fair.

Resulting effects on your life:

My friends were starting to treat me differently. I don't have a love life, job or career. I can't study when I try, as I get harassed. I live only off the VA disabilities. I get migraines. I used to be physically fit. I'm being monitored 24/7. I have been raped and threatened. Doctors just beat around the bush.

Date: 08/13/2019

First Name: [REDACTED]

Last Name: [REDACTED]

City: San Jose

US States: CA

Zip: 95125

Have you experienced coordinated stalking?

I stopped an organization from stealing an enormous amount of data from a major corporate conglomerate where I worked. Almost instantly I started being stalked by multiple unknown persons out of the south bay and lost my job, my place to live and my car. I now have debilitating PTSD in regards to this event. It's completely unfair and should be stopped.

Have you reported coordinated stalking to law enforcement?

The crime was reported to the San Jose Police Department around March of 2019.

Have you moved because of coordinated stalking?

Yes

Have you been mis-diagnosed by mental health professionals?

Yes

Resulting effects on your life:

I don't have a job now and I'm living with my parents, 5 hours away from my kids.

Date: 08/12/2019

First Name: [REDACTED]

Last Name: [REDACTED]

City: Sacramento

US States: CA

Zip: 95825

Have you experienced coordinated stalking?

I am stalked by different people everywhere and anywhere around the clock!

Have you reported coordinated stalking to law enforcement?

Yes, it just makes it worse!

Have you moved because of coordinated stalking?

Yes, just makes it worse!

Have you been mis-diagnosed by mental health professionals?

No

Resulting effects on your life:

It ruined my life. I have nothing, just barely surviving. I'm also under severe surveillance, and a lot more life destroying horrors!

Date: 08/12/2019

First Name: [REDACTED]

Last Name: [REDACTED]

City: Los Angeles

US States: CA

Zip: 90403

Have you experienced coordinated stalking?

I have experienced organized stalking either on foot, in a car, or traveling on a bus, plane, and train.

Have you reported coordinated stalking to law enforcement?

Yes, when I reached out to the police for help I was ignored or it was played down. I have not been taken seriously.

Have you moved because of coordinated stalking?

Yes, I have moved multiple times. I have stayed in hotel rooms where I was followed. Tried renting multiple different homes, rooms and apartments, but within a few days I was surrounded by the organized stalking individuals.

Have you been mis-diagnosed by mental health professionals?

I have not been diagnosed with any mental health issues

Resulting effects on your life:

As a result of the stalking I have become fearful to leave my house. Being followed everywhere and not knowing who will try to harm me causes me anxiety.

Date: 08/13/2019

First Name: [REDACTED]

Last Name: [REDACTED]

City: San Leandro

US States: CA

Zip: 94578

Have you experienced coordinated stalking?

I was a victim of organized stalking between 2017 and 2018. Almost everyday during this time period I would be followed by multiple vehicles every time I left my house. These cars would speed up around me, slow down and try to get me into an accident. The drivers would also point their phones at me showing me they were video taping me. In addition people would sit in their vehicles on the street where I lived for hours or in the parking lots of anywhere I would go, watching and waiting for me. Once I would get in my car and leave they would follow me once again.

No matter where they were they would honk their car horns to let me know they were there. Any public place I would go people would make rude comments trying to provoke me into an argument and would invade my personal space. Some of these people let me know they knew my personal information. Someone also had access to my vehicle because I would go outside to see it was totally unlocked even though I knew I had locked it.

My house was broken into multiple times and they would only take small items with very little value. Many times they took an oil I liked to use. I'd buy I new bottle and they would take it over and over again. On one occasion they even returned the bottle of oil empty. All my electronic devices were hacked into, even my work computer. They would make it impossible to use my cell phone because they would press buttons every time I was on a call. Once Hi was written in the notes of my phone and I did not write it. I had apple reset my phone twice but every time it would be hacked again. Because of all of this I didn't feel safe at home or anywhere I would go.

Have you reported coordinated stalking to law enforcement?

I did not report anything because I didn't think I had enough evidence and that I would be believed.

Have you moved because of coordinated stalking?

I was living alone and didn't feel safe so I eventually moved in with my family.

Have you been mis-diagnosed by mental health professionals?

I was very anxious and disturbed by what was happening to me and it was consuming my life. My family didn't believe me and thought I needed to get mental health treatment. I went to the hospital and to my surprise was held under a 5150 even though I was not a danger to anyone. I was misdiagnosed and forced to take medication I did not need, otherwise they would not release me. Health professionals are unaware that organized stalking is actually taking place, so they treat you as if you are imagining it. It was a very traumatic experience.

Resulting effects on your life:

The stalking has effected my whole life. It put a strain on my personal relationships with friends and family. I felt totally alone because no one else understood or believed what I was going through. My mental health was obviously effected. My career and finances were also ruined. Because of my hospital stay and time off of work I was let go from my job. Loss of income and unpaid hospital bills have ruined my credit as well.

Date: 08/15/2019

First Name: [REDACTED]

Last Name: [REDACTED]

City: Los Angeles

US States: CA

Zip: 90036

Have you experienced coordinated stalking?

Yes, you may ask how? Such tactics as gaslighting, smear campaigns and work place mobbing. Perpetrators are trained to stalk you and run a smear campaign by telling lies to the community to ruin our characters.

Have you reported coordinated stalking to law enforcement?

Nope. Never have because this is hard to confront due to its covertness, therefore deeming us as crazy people.

Have you moved because of coordinated stalking?

Yes, these perpetrators start the same thing over and over. They go around and tell the neighbors lies to put us at odds with them, therefore creating distinctions within the communities.

Have you been mis-diagnosed by mental health professionals?

No

Resulting effects on your life:

It has really helped me get closer to Almighty God. I pray that this will come to light, for God is a God of justice as well, and has a divine plan for humanity. Jesus will return to establish a righteous government, believe it or not. The result is there will be something amazing on "The day of Redemption."

Date: 08/16/2019

First Name: [REDACTED]

Last Name: [REDACTED]

City: Winlock

US States: WA

Zip: 98596

Have you experienced coordinated stalking?

I was targeted during the entire time I lived in Eureka, CA, and the stalking continued in Woodland, WA where I was targeted with work place mobbing as well.

Have you reported coordinated stalking to law enforcement?

I had repeated contacts with Eureka Police Department and Adult Protective Services in Humboldt County California to report the organized harassment.

Have you moved because of coordinated stalking?

Yes, twice.

Have you been mis-diagnosed by mental health professionals?

Yes

Resulting effects on your life:

My life is completely ruined by the constant targeting, gaslighting, baiting, badgering, etc. I have eliminated all unnecessary social interactions and became totally reclusive. I have demonstrated to myself that my experiences are quite real. I have tried to leave whatever evidence I can of my experiences for anyone to see if they look, and I will be done with humanity, hopefully sooner than later.

Date: 08/17/2019

First Name: [REDACTED]

Last Name: [REDACTED]

City: Los Angeles

US States: CA

Zip: 90036

Have you experienced coordinated stalking?

Since divorcing my husband (he decided to transgender, thinking he would be happier as a woman) I have experienced nonstop 3rd party stalking and harassment, vandalism and theft. My ex is part of a wealthy highly narcissistic family and I soon learned, from the ex-husband of my ex's sister, that this is what the family does when someone seeks divorce from one of their clan. He was cut off from their two children, and my ex is trying to do the same with me.

Our daughter, an only child, has been told that I've become psychotic and that I may commit suicide. She is afraid to talk to me now, feeling that this will upset her too much. During the divorce, my ex hired a woman to help him/her with our daughter who was 12 at the time. I soon found out from a private detective I hired that this woman came from an Italian family whose father was an il capo (captain) in the mafia, and my harassment has been extremely intense and mafia-like in its techniques.

I have lost two cars, three computers, friends, ruined credit, close to \$200,000 in scams, more smartphones than I can count, as well as much, much more. This has ruined my life and alienated my daughter from me. While I don't know the people who have stalked me in their cars, I do know many of the people who have swindled or conned me out of money, ruined my credit or caused me to face homelessness more than once.

I hope to be delivered one day from this horrific nightmare experience. But with my name besmirched at police departments and attorneys who don't know what to do with 3rd party harassment, I've no idea how to end this nightmare. I only hope greater public awareness will someday, hopefully soon, make this an easier case to prosecute and bring responsible parties to justice.

Have you reported coordinated stalking to law enforcement?

Yes, but getting needed plausible evidence is difficult at best.

Have you moved because of coordinated stalking?

Many, many times. Seven or eight times in nine years. And because of stolen phones, I've had many different phone numbers, losing touch with friends and associates.

Have you been mis-diagnosed by mental health professionals?

Yes. My sister who incidentally allowed herself to be bought into this program, had one of her sons put me on 5150 hold, saying I was suicidal, which I was not. When I did check into a hospital because I was so frightened and feeling like I was falling apart, this same sister informed the hospital staff that I was "acutely psychotic and delusional". I was very depressed but not crazy. By the way, this sister also tried losing my dog when her son had me on 5150. I now know how families can be taken in by the slander spread by these low-life, morally-empty stalkers.

Resulting effects on your life:

It's been nothing short of hell. I have lost a decade of my life to this insanity. And if I do indeed lose my daughter, I don't know what I will do.

Date: 08/17/2019

First Name: [REDACTED]

Last Name: [REDACTED]

City: Chico

US States: CA

Zip: 95926

Have you experienced coordinated stalking?

I have been attacked with everything from theft, harassment, strange men with sexual intentions. Complete strangers and some I had gone to school with shared with me that I need a full body MRI. They demanded me to leave my 33 acre property that we owned or we would be killed. It's traumatic and devastating. Please help us.

Have you reported coordinated stalking to law enforcement?

We have reported it many times.

Have you moved because of coordinated stalking?

Yes. Several times. They still torment and threaten me today.

Have you been mis-diagnosed by mental health professionals?

No. My mental health professionals have said they are sorry that this has happened to me and are told they cannot help other than give me acknowledgements and prayers.

Resulting effects on your life:

My health, family, career, savings, safety, and trust has been taken away from me. My home, my brother, father and community are gone. It's tearing down of my physical and mental health. My faith in God and a few ethical professionals are what has kept me alive.

Date: August 17, 2019

First Name: [REDACTED]

Last Name: [REDACTED]

US States: Fort Bragg, CA

Zip Code: 95437

Please write a brief summary of your experience with coordinated stalking only.

Many, many occasions, too numerous to count. People have been in my presence that resemble people I knew in the past or currently know. They are dressed similarly and use mannerisms of the persons they are impersonating. They will speak about things that are relevant and pertinent to me, indicating that my conversations and privacy have been heard and invaded. Also, an inordinate number of times vehicles drive around me that are the same make, model and color of the vehicles of people I once knew or know. If the vehicles aren't the exact make and model, they will be very similar. The frequency with which this continues to occur are beyond coincidental.

My vehicle was broken into on numerous occasions. Items were taken and then replaced later. I had looked several times in the exact places where things should have been and then they reappeared in that place. I believe my home had been broken into also. A flash drive was stolen.

My cell phone has been hacked numerous times. The camera has been turned on, text messages typed NOT by me, and phone calls missed because it didn't ring yet a voice message notification sounded. My phone was next to me each time this happened and the ring volume was fine. My computer has also been hacked: the cursor moved, web pages crashed, documents stolen and passwords known by others.

Please describe your experience if/when you reported the crimes to law enforcement.

I went to the Sheriff office to ask if the traffic patterns had changed to being excessively heavy. They could not give me a conclusive answer of any kind. I didn't file a report.

Please describe your experience of being misdiagnosed by mental health professionals if applicable.

I was placed on a 5150 hold without being a harm or threat to myself or others. I went to pick up my child at her father's home after being away for the weekend. This was a planned arrangement. I have no idea why the Sheriff's Dept. was called. No arguing or fighting had occurred. I believe this was an intentional set up by several people.

Please tell us if you moved due to the stalking.

Yes. I now know about coordinated stalking and what they can do, and did, to harm my life, but at the time I moved I was unaware of what this was.

Please briefly describe the resulting effects upon your life:

I have been denied employment and became homeless. I was financially ruined and my family offered very little support and eventually stopped communicating. My lack of trust is substantial. I suffer from trauma.

Date: 08/17/2019

First Name: [REDACTED]

Last Name: [REDACTED]

City: Long Beach

US States: CA

Zip: 90802

Brief summary of my experience with coordinated talking only:

I am currently being stalked 24/7 365 days. There are 20-30 vehicles daily that follow me when I make my rounds for work. They swerve at me acting as if they are going to hit me with their vehicle. They also slam on their brakes in hopes that I rear end them and cause a major accident on the freeway. It doesn't matter where I go whether its a hotel, a family or friend's house, they follow me and they'll be there before I get there to harass me.

They hack my phone lines and all my social media and emails. I am not involved in any criminal acts but I am a small business owner and have worked so hard to build my business to a lucrative business that takes care of my family and I. They have hurt my business tremendously so that my overall numbers have declined more than 60% due to them calling all my customers to lie to them about me in hopes of sabotaging me.

COMPANY NAME- [REDACTED]

They harass me all night, every night to keep me from sleeping for sleep deprivation. When I'm in the store shopping for food or what not, they will bombard me and try to intimidate me in hopes of making me feel claustrophobic and scared. I have been attacked mentally and physically and emotionally. I have in my possession FLY SPY DRONES that they used to spy on me anytime, anywhere in my home. I live with a girlfriend and her kids and they watch every intimate moment, taking a shower or using the restroom. And they watch everyone in my household so it's not just me. They have ruined the inside of my car by breaking in and hacking it. They hit my drivers side door by side swiping me. They have ruined 2 computers by wiping them out. And they have stolen another computer along with 3 different cell phones.

My experience if and when I reported the crimes to law enforcement:

Nothing has ever happened when it comes to the stalking part. I've been heckled and laughed at.

I have had 3 incidents in calling the police department and filing a police report::

1- Santa Ana Sheriffs Department (aprox.) June 2018. My home was burglarized and they stole my cable modem and my DVR because of my cameras around my home. They stole the evidence.

2 - Santa Ana SHERIFFS DEPARTMENT (APROX.) AUGUST OF 2018. My neighbor was cited and not arrested for throwing a fire extinguisher at my car and damaging it.

3 - Costa Mesa Police Department NOVEMBER OF 2018- Stalkers followed me to Starbucks. As I proceeded to leave I was followed and one of the Stalkers following me and pulled out a knife. I called 911 and a police report was made.

On the move:

I am currently in my 4th home due to coordinated stalking, and in between I've stayed with family and they never skipped a beat. They were even set up at my new location prior to moving in. The cities I've lived and they pursuit me was Costa Mesa, CA, Tustin, CA, Huntington Beach, CA. Long Beach, CA, Is where I'm living currently.

A brief summary of the resulting affects upon my life of the above 3 items:

I've battled depression, anxiety and loss of a lot of money. I've lost a lot of friends and close relationships due to my stalkers trashing my name and telling lies and rumors about me. The sabotage of my company and the loss of 60% of my customers because of the bad mouthing has extremely hurt me financially. I am on guard 24/7, 365 days because the people are bullies and are unpredictable. I dream of the day of having my life back to normal, but then again this has forever changed me as a person for the way I portray people and the world.

Date: 08/17/2019

First Name: [REDACTED]

Last Name: [REDACTED]

City: San Jose

US States: CA

Zip: 95111

Have you experienced coordinated stalking?

Yes. I have been followed and harassed by people both covertly and overtly. Lots of cars blinding me with flood lights making it a hazard to drive anywhere at night. Lots of cars waiting outside my house with their hazard lighters on then they leave simultaneously as I do. You might think maybe it's coincidental, but when it happens every day for months and months we begin to realize it's not.

Have you reported coordinated stalking to law enforcement?

Never. They can't help us.

Have you moved because of coordinated stalking?

Not yet.

Have you been mis-diagnosed by mental health professionals?

Not since this began.

Resulting effects on your life:

Can be tiring/exhausting to explain the complexity to people.

Date: 08/18/2019

First Name: [REDACTED]

Last Name: [REDACTED]

City: Sacramento

US States: CA

Zip: 95828

Have you experienced coordinated stalking?

For the past three years I've continuously been stalked 24 hours a day, 7 days a week. This is what the powerful do to the powerless. In cars, walking, flying, and any and every form of stalking possible I have now encountered. I've witnessed my stalkers hiding in trees, following me in cars, on foot, on vacations, in public, in church, at my children's sports events and schools.

Have you reported coordinated stalking to law enforcement?

At this time I have not made any police reports about my stalking. I've been harassed and physically hurt by police in their attempt to threaten me about what would happen if I went to the authorities about it. I'm scared to report to the law what the powerful do to the powerless due to retaliation.

Have you moved because of coordinated stalking?

No I have not moved although over the last 3 years I've watched my neighbors and neighborhood turn against me and join the powerful in their goal to destroy the powerless with their coordinated stalking.

Have you been mis-diagnosed by mental health professionals?

No. I have not told my testimony to any doctors.

Resulting effects on your life:

Since I have been a victim of organized stalking I've nearly lost my marriage and today it is still being held together by a string. I've had to endure a horrible smear campaign that is all throughout my community from my home to my children's school, their sports teams, my job, the stores I shop, on the road & even in the hospitals where I believe my dad became a fatality due to my stalking. There is no place I can go to get rid of organized stalking. It happens in every city, every town, every store, every restaurant, gas station, doctor's office, airplane, every freeway, park, beach, and even at my home. Organized stalking is not prejudiced and does not care when or where you are as it never stops. I live in fear of my life as well as my entire families lives 24/7.

Date: 08/18/2019

First Name: [REDACTED]

Last Name: [REDACTED]

City: Oakland

US States: CA

Zip: 94621

Have you experienced coordinated stalking?

Yes. I've been a victim of coordinated stalking.

Have you reported coordinated stalking to law enforcement?

Multiple contacts and complaints with DOJ, FBI, DEA, local law enforcement, Congresswoman Barbara Lee, Devin Nunes, OPD, EGPD, Alameda Sheriff Dept, Sacramento Sheriff dept., Hayward PD, lawyers, Alameda Superior Court, San Francisco Appeals Court etc. Continuously stonewalled concerning coordinated stalking and frame-ups.

Have you moved because of coordinated stalking?

Yes, I relocated to Elk Grove California where the coordinated stalking ratcheted up. I relocated to Hayward CA where coordinated stalking and frame-ups increased with attempts to incarcerate me.

Have you been mis-diagnosed by mental health professionals?

12/31/2017- I experienced heart palpitations and Kaiser Permanent purposely misdiagnosed me with schizophrenia and delusional. Held for 8 days while my cases were discredited and dismissed.

Resulting effects on your life:

Reputation ruined, family and friends attacked, 24/7 via aerial surveillance, ground surveillance.

Date: 08/18/2019

First Name: [REDACTED]

Last Name: [REDACTED]

City: Panorama City

US States: CA

Zip: 91402

Have you experienced coordinated stalking?

Well my experience start around 2017 when they started the stalking and harassment by many different people, different cars.

Have you reported coordinated stalking to law enforcement?

I tried to report this crime, but when I tried explaining to the officer, he asked if I have scars he can make the report on. When I insisted, he recommend I go to the psychologist because he didn't believe what I said. This happened around August 25, 2017 in San Fernando California.

Have you moved because of coordinated stalking?

Yes. I travelled to Guatemala, and they were there too. I made a police report and I have my family as witnesses. Because those people attacked my family too, they can explain their experience, too.

After that I travel to Houston, Texas with my family there, and they were attacking there, too.

Have you been mis-diagnosed by mental health professionals?

When this happened, I was thinking that when I visited the hospital several times, they sent me to the mental health doctor, and I thought that this is exactly what those people want. I didn't go to the mental health doctor. I chose to travel to Guatemala because I knew that there nothing wrong with me. It's because what they're doing to me.

Date: 08/19/2019

First Name: [REDACTED]

Last Name: [REDACTED]

City: Daly City

US States: CA

Zip: 94014

Have you experienced coordinated stalking?

The features that I have noticed most in regard to my organized stalking is as follows:

Large groups of people surrounding me wearing similar outfits in the exact colors I am wearing. I have come to refer to that as Color Mobbing. Also, I am followed all day long by cars that are the same color as I am wearing. For example when I leave the house wearing yellow I see a lot of yellow taxis behind, to the side and ahead of me. On days I wear blue I no longer see any yellow taxis but am followed around by a lot of blue cars. This has been happening every day.

Another feature of my organized stalking is a huge smear campaign where I have been told that someone heard that I was a pedophile, others heard that I was the Queen of a Burglary Ring and another person heard I hit someone with a broom. None of these stories are true - in fact my personality is completely opposite of all of these statements. I don't have a history of being dangerous, have never been accused of anything regarding children and have never hurt anyone in my life. I have no felonies or misdemeanors. My long time friends and many relatives are all under the impression that I have done something wrong, but they won't tell me the details.

The other feature of my organized stalking is all day coincidences. If I am painting inside my house with green paint on a canvas I will get a creepy cryptic call from Ace Hardware with a woman blaring into the phone Sale Today at Ace 50% off on all green paint. So I am under the impression that I am being surveilled inside my own home and then made to feel unsafe with people calling me to tip me off to what I am doing during the day in the privacy of my home. So coincidences all day long are actually ways that I am being terrorized. People making contact with me in strange ways to make me feel as though I am under surveillance.

Have you reported coordinated stalking to law enforcement?

Yes. Around 2003 I returned to our home in San Francisco after being out all day and found that my brother-in-law, [REDACTED] had broken in. I chased him out the back door to his bottom unit in the same building. When I told him I was reporting this to police he told me go ahead, see what I do to you next. A threat. I then contacted police and they would not take my report. I went back to the police department a couple of days later and begged them to take the report because many other strange things were happening with [REDACTED]. The officer then directed me to Officer Kelly Dunn for a psyche evaluation. I thought that was strange but did it anyway. After spending several hours in an interview with Officer Kelly Dunn of SFPD she made up a report stating that she thought I was suffering from schizophrenia, yet she did not add into the report that my home had been broken into by [REDACTED] and that he admitted to it. So the report leaves out the name of the person stalking me, and Kelly Dunn goes on to make me look crazy.

My stalking ramped up from there. Kelly Dunn has a history of making women in San Francisco to look crazy. Research the case of Christine Harris. This woman sued Officer Kelly Dunn and SFPD due to a situation similar to mine.

Have you moved because of coordinated stalking?

No. I have heard from other victims that all communities are in on this and that it wouldn't help to move.

Have you been mis-diagnosed by mental health professionals?

This is a good one! I have 2 therapists that I have been going to for about 7 years. Both of them are willing to testify that I am NOT suffering from any mental disorder or condition. I show no symptoms of any form of paranoia or
(cont'd)

delusion. It has been mentioned by a police officer (above) Kelly Dunn that she claims I am paranoid. This is absolutely false. My brother-in-law was caught in my home and he admitted it and Kelly Dunn still claimed that I was paranoid.

Resulting effects on your life:

I now have a very hard time leaving the house, I no longer work and I used to be the most outgoing person I knew. I was very confident, with hundreds, maybe thousands of good friends! I now suffer from agoraphobia. Thanks for letting me share. Good luck on this effort!

Date: 08/19/2019

First Name: [REDACTED]

Last Name: [REDACTED]

City: Lakeside

US States: CA

Zip: 92040

Have you experienced coordinated stalking?

I am 66 years old. It started while working at the Hyatt Lake Tahoe as a casino dealer, and I would later speak with two other people who had the same experience as me at the same time period in that area. At the time, I was seriously ill, and something was done to me while I was working a Blackjack game - completely incapacitating so that I could not run my game and probably done to scare me into leaving my job. Since then I have lived with 24/7 complete life interference. And if one has not experienced this atrocity, one would likely never believe it. I don't generally share this problem with anyone except other people experiencing the same atrocities.

I have also experienced strange behavior from suspect neighbors and from persons unknown to me while shopping or going about my daily business in my smallish town, at medical appointments and cancer treatments. I have heard the suspect neighbors telling their children not to feel sorry for me, as if I am an aberration. This is hate being taught to children.

I have heard of myself referred to as a child molester, animal, elderly abuser, thief, liar, and a drunk. This sort of talk keeps people from wanting to know me, and certainly helps clear the way for unadulterated harassment. And yet, I have needed to work and support myself. I was often made aware that calls were made to different employers, and work life then became unstable and unsafe. With each new employer it would begin again: jokes made about me as I tried to work. At one point I walked into County Mental Health just to check myself. I was quickly deemed clear thinking, well spoken, nicely dressed, obviously in charge of myself - not exhibiting any signs of mental illness.

So life is more than difficult. Knowing that I am under 24/7 surveillance, that neighbors and strangers may be involved is more than a little daunting. Every day is a battle to keep going. All exhausting and never ending. A few years ago I was diagnosed with Chronic Leukemia. Nothing like it ever in my family before.

None of this is normal or okay. This is an unseen crime that it seems anyone with enough funds can pursue, and it should not be allowed to happen to any citizens or anyone anywhere. I have read that we are up against a 4 billion dollar industry that pays work places and regular people to spy on and harass others, to break into homes, damage vehicles, possessions and animals. I sometimes experience suspected perpetrators behaving with an uncanny thrill of bloodlust, as if they are on their first kill, and thrilled by it, no worries about being caught or taken away to jail, and they will say so - "She can't prove it". So scary!

Please, please, please enact legislation that would prohibit organized stalking, enact serious penalties and protect victims. Otherwise, our wonderful state, our wonderful country are in for a bad time. People are suffering and dying. Lives are being destroyed. This is passive killing - and I have heard it called that by people harassing me. This is organized crime. Legislation to protect citizens, property and pets is needed now. Thank you for your time.

Date: August 16th, 2019

Your Full Name: [REDACTED]

City: Barstow

Zip Code: 92311

Please write a brief summary of your experience with coordinated stalking only:

My experience with coordinated stalking is that our family are the victims of organized stalking. Whenever we leave our house, there is a white car waiting in the street, and someone usually gets out of it. They stare at us, and when we leave, they go to the apartment of a person we know is the main stalker. Several cars follow us everywhere. When we go to the store, the stalkers know someone at the store and they are in on the stalking.

When I went to school, there is always someone stalking me with a group of people. This is an everyday encounter where we have no privacy and no sense of sanity. The window to my car has been broken, and our tires have been slashed. No one seems to know what is going on.

We are constantly being victimized, and there is no way to stop it. My father and I manage an apartment complex and every time we let someone in the building, they victimize me and my father. We have told the police, but the police will not do anything about it. We have seen them help the very people who are stalking us. There is no end to this nightmare.

Please describe your experience if/when you reported the crimes to law enforcement.

We tried to contact the police, but the police will not do anything about it. They have not taken any reports. They have refused. When we contacted the FBI office in Los Angeles, they would not even listen.

Please describe your experience of being misdiagnosed by mental health professionals if applicable.

Not Applicable

Please tell us if you moved due to the stalking:

We have moved out of our apartment because we were constantly stalked. We have not found any peace because we could not afford to move very far.

Please briefly describe the resulting effects upon your life:

We still haven't found any peace whatsoever. We are still being stalked. We have decided that we would not call the police again because they are not willing to help us. We have no way of protecting ourselves from being stalked. It is still happening.

Date: August 16th, 2019

Your Full Name: [REDACTED]

City: Barstow

Zip Code: 92311

(Note: [REDACTED] is the father of [REDACTED])

Please write a brief summary of your experience with coordinated stalking only:

Whenever my son and I leave our house, there is a white car waiting in the street, and someone usually gets out of it. They stare at us, and when we leave, they go to the apartment of the person who we know is the main stalker. Then a few cars start to follow us everywhere. When we go to the store, the stalkers know someone at the store and they are in on the stalking.

We are constantly being victimized, and there is no way to stop it. My son and I manage an apartment complex and every time we let someone in the building, they victimize me and my father. We have told the police, but the police will not do anything about it. We have seen them help the very people who are stalking us. There is no end to this nightmare.

Please describe your experience if/when you reported the crimes to law enforcement.

We tried to contact the police, but the police will not do anything about it. They have not taken any reports. They have refused. When we contacted the FBI office in Los Angeles, they would not even listen.

Please describe your experience of being misdiagnosed by mental health professionals if applicable.

Not Applicable

Please tell us if you moved due to the stalking:

We have moved out of our apartment because we were constantly stalked. We have not found any peace, because we could not afford to move that far.

Please briefly describe the resulting effects upon your life:

We still haven't found any peace whatsoever. We are still being stalked. We have decided that we would not call the police again because they are not willing to help us. We have no way of protecting ourselves from being stalked. It is still happening.

Date: 08/20/2019

First Name: [REDACTED]

Last Name: [REDACTED]

City: North Miami

US States: FL

Zip: 33161

(Note: we are including out Oof state testimonies if person was a former California resident and experienced coordinated stalking while in California)

Have you experienced coordinated stalking?

Yes.

Have you reported coordinated stalking to law enforcement?

Yes, called the Irvine, CA Police Department & visited the FBI's Miami office.

Have you moved because of coordinated stalking?

Yes

Resulting effects on your life:

Disabled and homebound.

Date: 08/20/2019

First Name: [REDACTED]

Last Name: [REDACTED]

City: Phelan

US States: CA

Zip: 92371

Have you experienced coordinated stalking?

I'm followed every time I leave my house. I have no privacy anymore. They throw stuff at me while I'm driving, and if I drive at night, they put high beams on me, so I try not to drive at night. They stole stuff from my house and damaged my car. The worst thing so far is they stole two of my dogs and I believe they murdered them. That's just a small part of what they have done. It never stops.

Have you reported coordinated stalking to law enforcement?

Yes. I contacted Phelan Sheriff's Department back when I didn't even know the term coordinated stalking, but nothing became of it. They wanted to know who the perpetrators were, and I told them I didn't know.

Have you moved because of coordinated stalking?

No, but I changed jobs thinking it would stop, instead it got worse.

Have you been mis-diagnosed by mental health professionals?

No

Resulting effects on your life:

I'm stressed out all the time and it's affected my marriage. It's hard for me to do my job and I'm worried as soon as I leave my house because I think that am I going to be killed. I don't go anywhere when I'm home. I can't tell my family, only my husband sees what's happening.

Date: 08/20/2019

First Name: [REDACTED]

Last Name: [REDACTED]

City: Huntington Park

US States: CA

Zip: 90255

Have you experienced coordinated stalking?

I've experienced many different forms of discreet harassment by total strangers. Cars that are parked on my street make high pitched sounds and helicopters show up anywhere I go. White unmarked cars follow me, and literally drive me crazy with obnoxious noise in the middle of the night, for no apparent reason.

Have you reported coordinated stalking to law enforcement?

No.

Have you moved because of coordinated stalking?

No

Have you been mis-diagnosed by mental health professionals?

No

Resulting effects on your life:

Anxiety and non stop paranoia and a feeling of imprisonment

Date: 08/19/2019

First Name: [REDACTED]

Last Name: [REDACTED]

City: L.A.

US States: CA

Zip: 90026

Have you experienced coordinated stalking?

Yes. Especially in grocery stores, parking lots, bus stops, and any public place.

Have you reported coordinated stalking to law enforcement?

Yes. I filed a complaint with the Westwood FBI office. At the time, I thought the stalking was organized by the Church of Scientology.

Have you moved because of coordinated stalking?

No.

Have you been mis-diagnosed by mental health professionals?

No. I have never been diagnosed with a mental disorder.

Resulting effects on your life:

Feeling prevented from having serious relationships with others, being black-listed and completely shut out of having any of social life.

Date: 08/29/2019

First Name: [REDACTED]

Last Name: [REDACTED]

City: San Diego

US States: CA

Zip: 92101

Have you experienced coordinated stalking?

I endure stalking by mall security guards, San Diego Metro Transit guards, security guards in my residential building, and even bank security guards. The guard stalking includes following me, intercepting my path with pinpoint precision, menacing glowers, loitering by my front door to take a photo of me as I enter my residence, verbal abuse (I recorded a 9 minute video tirade by an MTS Officer). I endure coordinated vehicle stalking and mobbing.

I tend to park with no spaces on either side. When I return, there is typically someone in a car next to me, engine running, or someone with engine running in front of me, headlights shining at me. My movements inside my home are mimicked on the street. I have found a single white Kleenex on my desk, side of bathtub, in my car, and along the path where I walk my dog.

I experience car's engines turning over by the dozen when I walk through a parking lot. I experience mobbing when I shop at the grocery store, Office Depot, Home Depot, and CVS. I have no privacy. My phone conversations, medical history, conversations with attorneys, are repeated in a scripted manner by strangers in public, who intentionally place themselves near me. I experience daily home invasions that involve moving personal items/furnishings, damaging walls, moving food in the fridge, etc. My car has been vandalized, cell phones have disappeared and sometime re-appeared. My phone, security, and computers are hacked.

Recently, I visited the ER as an outpatient for several days, and was shocked to experience stalking and harassment in the ER parking lot by three nurses and by another patient whose room I shared while waiting for treatment. The man claimed to have a hurt foot, but participated in the predictable scripted conversations that I experience in public by strangers. His foot had a healthy color, neither swollen nor mis-shaped.

I experience men yelling "fuuuuuck" angrily into my open car window so much that I keep my windows up when driving near pedestrian areas. I repeatedly have men running towards me (not athletes) when walking by myself at night; sometimes with something like a camera; once with an 6' tree branch. There is always someone waiting for me in the still of the night, just to let me know I am not alone.

I had my front door re-keyed twice within the last 8 days. It does no good. My vehicle was moved in a parking garage to a spot I did not park it in. I experience regular stealth entry into my home. These are expert criminals.

I experience doppelgangers of people I have known or know now in my life. The amount of effort to research and accomplish this astounds me. If it is someone I knew 30 years ago, they appear as they looked then, dressed in clothing, jewelry, hairstyle even shoes as I knew them. Face, body type. A doppelganger of my own mother, who passed 10 years ago, appeared recently at the grocery store. The resemblance was striking. At Seaport Village, a group of five black men jumped out of a car, dressed in red and loudly shouted at me that I am a racist. Then a woman wearing a burka walked by and said, "yes she is a racist". A man glided by on an electric scooter chiming in "yes, she is a racist", and called me a bitch. A mob gathered around me, yelling and filming me. The intent of that abusive stalking/confrontation was to invoke fear.

Have you reported coordinated stalking to law enforcement?

I have reported multiple break-ins, property disturbances that were coordinated, incidents where men ran up close to me with a black photo-lens camera (I now see men downtown all the time with those cameras around their neck, acting like they are taking photos of something right in back of me), a front door jam that was repeatedly busted.

The result is that I could not report anything stolen; there was no sign of a forced entry that the police could verify
(cont'd)

(door jam just looked busted to them); and police would ask, “Who would want to do this to you? This is such a safe building/front door. How do you think they are getting in?” I have no answer, other than it must be someone in the building.

Have you moved because of coordinated stalking?

Not yet

Have you been mis-diagnosed by mental health professionals?

A neurologist that I visited for something else, and before I fully understood I am a victim of coordinated stalking, was edgy towards me while asking me intake questions. He wanted to prescribe me antidepressant medication. I did not want to accept a prescription from a neurologist after meeting with him for only 20 minutes.

Resulting effects on your life:

This has been a devastating experience. The slander, stalking, home invasions, mobbing, is debilitating. I am disorganized, experience extreme exhaustion, and my attention span is reduced. It has brought financial and career devastation. I have become socially isolated. My civil rights are violated daily.

I know what normal is. This is not normal. I am in my fifties, a single straight woman with no partner and no children. I don't know how much longer I can survive and function living like this. I feel that I must fight not only to regain control in my own life, but to fight for the rights of other victims.

I now facilitate support groups in several cities and several states: Hawaii, California, Oregon, Nevada, Arizona, Florida, New York, Ohio and several more. This is a volunteer effort. I have begun to speak out at City Council meetings, educating them about the organized harassment. This is not something I relish doing. I am a shy and private person. But this is my Civic Duty.

Date: 08/28/2019

First Name: [REDACTED]

Last Name: [REDACTED]

City: Sacramento

US States: CA

Zip Code: 95818

Please write a brief summary of your experience with coordinated stalking only:

I have been a victim of coordinated stalking for a while now. My experience first started about a year after I moved into my new neighborhood. I started noticing that when I leave my driveway someone would leave at the exact same time as me. I thought it was just a coincidence until it started happening more and more often. That was my first experience. Then I started noticing that I was being followed to and from work by complete strangers that were unknown to me. Next, road bullying began to occur. Every time I reached a corner block, a car would be waiting for me at that same exact moment. This happened more and more often and at various times in the morning such as 5:30am or 6:00am. That was my second experience.

My third experience then started with noise campaigns while I was at home. Car alarms being set off at random by my neighbor and followed by other neighbors. The noise campaigns would occur in the morning, various times in the afternoon and at night. Neighbors with motorcycles would also turn on their engines and rev their engines, which could then be heard by anyone within 2 blocks of my home. The noise was so loud that it would draw your attention to the origins of where it was coming from outside.

Please describe your experience if/when you reported the crimes to law enforcement:

I tried to file multiple police reports about the noise campaigns and coordinated stalking with the police in Elk Grove, Sacramento County and West Sacramento County; all police representatives said they could do nothing about it since there was no single perpetrator or restraining order in place. This is where a loophole in the law exists and our complaints are unjustifiably ignored. Coordinated stalking is an instance of bullying, however, it is not investigated by the police. I called and met with many officers, but they all said they can't investigate these crimes since more than one person was involved.

Police also questioned if I could be delusional, questioning my statements about the coordinated stalking, such as why would someone want to stalk me. I said because they have the power to do it.

Please describe your experience of being misdiagnosed by mental health professionals if applicable.

I have been questioned by police regarding my mental state. For example, being delusional, paranoid or other, and my response every time was "NO WAY."

Please tell us if you moved due to the stalking:

Yes, I have twice.

Please briefly describe the resulting effects upon your life:

It has put tremendous strain on my relationships with others because mentioning coordinated stalking with others labels me as paranoid or delusional. I am slandered to new friends and neighbors who then turn against me, down the road. It is very hard to build new friendships or go any places without the thought of being followed. My freedom has been taken from me and I often feel isolated.

Date: 08/29/2019

First Name: [REDACTED]

Last Name: [REDACTED]

City: Desert Hot Springs

US States: CA

Zip: 92240

Have you experienced coordinated stalking?

The organized stalkers would drive behind me or by the side of my car. They come to where ever I am and stare at me, try to take money from me and no one is ever helpful, only hurtful.

Have you reported coordinated stalking to law enforcement?

I reported to the Los Angeles police, but don't remember the name of the station. The sargeant listened to me, then gave me pamphlets for homeless shelters. That happened on Father's Day 2016.

Have you moved because of coordinated stalking?

Yes.

Have you been mis-diagnosed by mental health professionals?

N/A

Resulting effects on your life:

I have been very ill and isolated from family and friends because of harassment. I am also treated badly in the community.

Date: 08/27/2019

First Name: [REDACTED]

Last Name: [REDACTED]

City: Sacramento

US States: CA

Zip: 95834

Have you experienced coordinated stalking?

I'm a victim of organized harassment, 24/7 surveillance, and community based stalking and noise campaigns. My neighbors are involved. This is unconstitutional and unfair. Sacramento Sheriff told me this would happen. We moved and it still happens at the new house. The torture has been going on for 3 years. Please put a stop to it.

Have you reported coordinated stalking to law enforcement?

Yes, I reported it to the Sheriffs and local law enforcement.

Have you moved because of coordinated stalking?

Yes. We moved and it still happens at the new house.

Have you been mis-diagnosed by mental health professionals?

No.

Resulting effects on your life:

I've been stalked and harassed for 3 years. It began after a dispute with the neighbors. We moved, but the organized stalking followed us to our new location.

Date: 08/26/2019

First Name: [REDACTED]

Last Name: [REDACTED]

City: Lakewood

US States: CA

Zip: 90712

Have you experienced coordinated stalking?

I experience coordinated stalking every day. There is never a day that I don't have to face the cruelty of a member of these criminal organizations. Not only do I have to experience it, but my daughter also experiences it at her school with the students, as well as her teachers.

Some of what I have experienced is: street harassment, slander, entering your home when you are away, destroying your electronics, etc.

My Daughter has been harassed by students and the teachers at her school. She has been given lower grades than she deserved. I feel this has been so detrimental to her. She has cried many days because of how she was treated at school.

This type of behavior has no place in a civilized society. We are not building up our country, but will tear it down if this continues.

Have you reported coordinated stalking to law enforcement?

When this first started, I reported it to the law enforcement, but they never did anything, and most times they would not even write a report, so I stopped calling them.

Have you moved because of coordinated stalking?

I have moved, but not necessarily because of the stalking. Each time I moved, the stalking would follow me.

Have you been mis-diagnosed by mental health professionals?

When I went through my divorce, my ex-husband and I went through some evaluations, and some of what appeared in the report was not true. I felt the entire divorce was manipulated.

Resulting effects on your life:

The resulting effects on my life are that I was laid off from my job because of the stalking. I was an engineer and worked for Boeing for 18 years, and have never been able to find a professional job again. Stalking has caused me to lose everything including two businesses that I started. The stalking has affected every thing in my life. There is no end to the lies that are told about me. They even go to my church and tell the church members lies.

Date: 08/24/2019

First Name: [REDACTED]

Last Name: [REDACTED]

City: South San Francisco

US States: CA

Zip: 94080

Have you experienced coordinated stalking?

My experience with Organized Harassment started with a neighbor across the street named Miss [REDACTED] her son, [REDACTED] and his wife [REDACTED]. I believe these are their names. It began after I confronted the old lady about her accusations towards my other neighbor [REDACTED]. I started noticing a small light (plugged in night light) in her window and she has these flip down blinds curtains she would adjust and light up different areas. I began noticing a pattern she would play and that made me have less respect for her and her evil ways. It's not the light itself, it's the fact that an old lady likes to play games. Many neighbors she talks to started a noise campaign and I began finding a lot of things missing from my house. I also started getting a lot of harassment at my old job as a City of San Francisco bus driver. I was told Miss [REDACTED] her son, [REDACTED] and his wife [REDACTED] organized many of these events.

Have you reported coordinated stalking to law enforcement?

Yes, I was called crazy.

Have you moved because of coordinated stalking?

No. I'm more worried about what I would do to them. I know how evil works and I'm doing the best I can to stay in my spiritual sector, though sometimes that is hard, and being there for my family. I quit almost all of my bad habits, except cigarettes, but I'm currently working on it.

Have you been mis-diagnosed by mental health professionals?

Yes. I was diagnosed with depression.

Resulting effects on your life:

Everyone screws up and tries to pick themselves up and do better! Why should they be deemed blacklisted by the POWERFUL who conduct themselves not just in the same, but even worse manner.

Date: 8/22/19

Your Full Name: [REDACTED]

City: Bakersfield

US States: CA

Zip Code: 93308

Please write a brief summary of your experience with coordinated stalking only:

Currently, I am a victim of a vicious smear campaign. A campaign with malicious intent to hurt me and my family. People in a position of power apparently can do this to people who are powerless.

At present time, I am stalked and followed by multiple people. I experience daily numerous vehicles following me, cars swerving, honking, color coordinated vehicles, and cars boxing me in. I continue to encounter electronic hacking of emails, my passwords being changed, phone communication, texts, pictures, and calls tampered with.

I experience noise harassment at my home. Horns honking, fireworks, loud engines, even sirens while I'm outside or when our lights go out for the evening. My husband is followed by vehicles daily. My son is also being brutally stalked. He has been blacklisted and cannot hold a job. He has had to stop his educational pursuits.

I am raising my granddaughter while being followed to parks, swimming, etc. She has been pushed and ignored by the children of these perpetrators while playing. She is not yet 2 years old! Our vehicles have had windows broken out, scratches, slashed tires, and multiple nails in the tires.

Please describe your experience if/when you reported the crimes to law enforcement.

8/18/2016 – Kern County Sheriff- Dispatched laughed at amendment to the report of theft.

9/07/2016 – Kern County Sheriff- Officer did not believe me when I reported several cars and multiple people following me in my neighborhood.

Please describe your experience of being misdiagnosed by mental health professionals if applicable.

Does not apply.

Please tell us if you moved due to the stalking.

We are discussing this topic now.

Please briefly describe the resulting effects upon your life:

I can no longer go for walks or most public places without disruption. More money is needed for repairs to vehicles, medical bills and technologies to document. This has taken an enormous toll on my health and marriage. I continuously worry for my family's safety and our future. I keep my family at a distance for their own safety. I also worry about the Law Enforcement not helping or taking us seriously.

Date: 08/29/2019

First Name: [REDACTED]

Last Name: [REDACTED]

City: Vacaville

US States: CA

Zip: 95687

Have you experienced coordinated stalking?

Yes, I have experienced organized stalking. My neighbors have threatened me. I've been followed by coordinated stalkers to stores and doctor's offices. I've been harassed, beaten, kidnapped, and held hostage. I feel like I have no privacy or rights.

Have you reported coordinated stalking to law enforcement?

I contacted Detective Matt Anderson of the Richmond Police Department. On October 2, 2015 I called the Secret Service and asked if they were aware of organized stalking, but they said they knew nothing about this crime and told me to contact the FBI.

When I spoke with the FBI, they informed me there was nothing they could do to help me. I told them I must protect myself since my life was constantly being threatened, but they just hung up on me.

On October 12, 2015 I called the Contra Costa Sheriff's office to report a vehicle that attempted to run me off the road. I spoke to officer Ferrario who did not call me back after the initial conversation.

I contacted the sheriff's office again on October 22nd about another incident that occurred in Tara Hills, CA where I was carjacked and held without my consent for 8 or more hours. During that time, I was being held up with some girl with a butcher knife. I was later taken back to my car and the guy who drove it tried to run it into a stop sign. When this happened, 3 Sheriffs witnessed it but did nothing. My car received damage to brakes and fluid leakage.

On March 15, 2015 a police supplemental narrative was filed by officer Cassandra Johnson and another supplemental report from Justine Takacs and officer Christopher Fod.

On March 16, 2015 I filed an incident report with the Contra Costa County Detention Facility.

On March 18, 2015 the neighbors who've been stalking me filed a restraining order against me and I received a disciplinary hearing report while I was in jail. Also, a felony and clerks docket and minutes. I have more times and dates and can present it all as needed.

Have you moved because of coordinated stalking?

Yes, I have moved several times, but they have continued victimizing me.

Have you been mis-diagnosed by mental health professionals?

Yes, I have. No one would listen to me! I was arrested and placed in a psychiatric ward. I have documented all of this.

Resulting effects on your life:

I have lost all of my friends, family, my dog, and I've had to spend money on my cat. I received threats and I'm completely isolated. I have several medical issues and suffer panic attacks and pain all over my body. My teeth are cracking and falling out, and I need approximately \$30,000 worth of dental work to get it fixed, but since I am disabled, I can't afford it. I'm currently seeking MediCal and have a new doctor. My doctor referred me to a social worker, Rachel, who asked me if I've ever seen a psychologist or counselor after I told her I was a victim of coordinated stalking, and asked me for names. I asked her if she had any knowledge of organized stalking. She was clueless. I asked her how does she expect to help me or refer me when she has no interest in acknowledging the existence of this horrific crime.

Dr. Parker is now trying to treat all my medical issues. It's very difficult for me as I'm under great duress.

Date: 04/01/2018

First Name: [REDACTED]

Last Name: [REDACTED]

City: Los Angeles

US States: CA

Zip: 90290

Have you experienced coordinated stalking?

I began to experience coordinated stalking in California. It has heavily involved the psychopath [REDACTED]. I am a female theoretical physicist. In early 2018 I was working at [REDACTED] in Los Angeles. It was the only serious job offer I received in the ten years since leaving Oxford University in 2009.

Have you reported coordinated stalking to law enforcement?

Over the last 6 years I filed many reports with the New Zealand police and other government bodies, including a report that [REDACTED] is a stalker. I am 100% certain he is a psychopath. I am a long term victim. I was written off as paranoid and was abused by the mental health authorities for many years.

Have you moved because of coordinated stalking?

I moved many times and was homeless for years. I continue to have problems.

Have you been mis-diagnosed by mental health professionals?

I was misdiagnosed as paranoid and psychotic. I was pumped full of Risperidone in 2014 and 2015, was prescribed Mirtazapine for depression and ordered to take 15mg of Zopiclone every day. I suffer from chronic insomnia. After two years of talking to psychologists, psychiatrists and nurses, no one has ever considered the possibility that I was telling the truth about being abused.

The doctors ignored my continuing severe malnutrition, which almost led to my death on a number of occasions. I absolutely have no doubt it's a coordinated effort.

Resulting effects on your life:

My whole life has basically been stolen from me and I have been forced into homelessness. I am a leading theoretical physicist who is shunned by other professionals. I'm always living in poverty, with no hope of escape.

Date: 09/02/2019

First Name: [REDACTED]

Last Name: [REDACTED]

City: Tustin

US States: CA

Zip: 92780

Have you experienced coordinated stalking?

Yes. They used the phone to listen to everything and everyone in my life and then used it all against me, even when things were not true. I called the cops I begged for help. I've experienced street harassment and people screaming at me. I discovered my house and car unlocked, but nothing removed.

They jammed my Internet and made my GPS take me in circles, resetting itself. They made my phones flicker off and on. They knew I had seizures and it was dangerous for me. They also turned on the Pandora radio on full blast at different hours of early morning, startling me awake. My phones have been hacked and infected with viruses and I was almost run off the road.

Have you reported coordinated stalking to law enforcement?

Yes, I have reported it to law enforcement and made numerous calls, but they stopped taking my 911 calls. They illegally raided my house with false warrants which were not even issued for me. They humiliated and violated me by making me stand naked in front of them for more than 5 minutes, refusing to let me put my clothes on. These cops are involved.

Have you moved because of coordinated stalking?

Yes, I moved out of state twice, but since they followed me, I decided to come back as it was all the same. I move almost every year.

Have you been mis-diagnosed by mental health professionals?

Yes.

Resulting effects on your life:

I now have PTSD and my Chiari's Disease was activated when they attempted to kill me in a car accident on two occasions, causing me to have seizures. I lost just about everyone in my life. All my friendships have been ruined, as well as my entire life.

Date: 09/02/2019

First Name: [REDACTED]

Last Name: [REDACTED]

City: Concord

US States: CA

Zip: 94520

Have you experienced coordinated stalking?

I have been stalked with vengeance and have had numerous encounters with individuals following me every time I leave my home. I am being stalked 24/7.

Have you reported coordinated stalking to law enforcement?

When the stalking became obvious, I spoke with an officer by the name of Jamie Cartwright. I met him and officer Mat at a Chevron gas station. Officer Jamie followed me to my house to write a report and told me that I would be able to pick up a copy of the report in a few days. It appeared that Jamie Cartwright was completely coherent and understood the information I provided to him at the time. When I arrived at the police department to get a copy of the report, I was in disbelief at the single paragraph the officer had filed in the report. He twisted the information he had taken from me to make it appear as if I were delusional. At that point I realized that this was something much bigger than just me. The stalking continues to this very day, and although over time I have adapted to living with the constant stalking, it is difficult to live a normal, happy life with those constantly stalking me in the shadows of my every footstep.

Have you moved because of coordinated stalking?

Since the start of of my organized stalking, I have moved 9 times in an attempt to escape it. I tried moving my things to storage for several weeks in hopes that I would be able to escape the hands of the organized stalking, but nothing has ceased.

Have you been mis-diagnosed by mental health professionals?

I have been extremely fortunate to not have been mis-diagnosed by a mental health professional. My father experienced the same type of stalking in 1989, which led him to commit suicide in April of 1992. He was 33 years old and I was 16 years old at the time. My father left behind some letters he had written regarding what he was experiencing during those years of his life. In his letters he described his experience of going to the police to inform them of what was going on and of constantly being stalked.

It was my father's letters that saved me from the experience of being misdiagnosed. I have his original letters in hand.

Date: 09/02/2019

First Name: [REDACTED]

Last Name: [REDACTED]

City: Santa Ana

US States: CA

Zip: 92706

Have you experienced coordinated stalking?

Yes. I feel like a human experiment. They are recording me and I'm under surveillance 24 hrs a day, without a probable cause.

Have you reported coordinated stalking to law enforcement?

I'm too afraid to report it.

Have you moved because of coordinated stalking?

I have relocated several times, but the stalking situation follows me everywhere I go.

Have you been mis-diagnosed by mental health professionals?:

I was diagnosed with schizophrenia while I don't have any problems with my mind.

Resulting effects on your life:

My life has been destroyed and I'm left being perceived as crazy, while I'm sound and stable. As a result I'm unable to work or be productive.

Date: 09/02/2019

First Name: [REDACTED]

Last Name: [REDACTED]

City: Elk Grove

US States: CA

Zip: 95624

Have you experienced coordinated stalking?

Yes, I have experienced different people stalking me or waiting for me at places when I arrive there. I know this because some of these people are not that good at stalking and make it obvious they don't want to be seen. For example, people I have never met before give me a "tough stare," as if I've done something wrong or hurt someone, which I have not. Also, complete strangers take a "double take" at their phone and then at me, point at me, and they do so as I am exiting a building. There are stalkers that appear intimidating, making it obvious they are there to watch me. Another example is when strangers walk by me and say, "there he is" or "that's him." I have also overheard people comment on what I have been doing inside my house while I was alone. These people throw what appear to be signals to each other. These events have not just happened on a few occasions, but multiple times on a daily basis.

Have you reported coordinated stalking to law enforcement?

Dates and times will take time to get and can be provided at another time. I have contacted the Elk Grove Police Department approximately 3 times and the FBI once. The EGPD dismissed my claims of coming home from work and finding the gas on my stove turned on (I live alone and don't cook).

They tried to derail me and my other claims and suggested I get a psych evaluation. I also filed reports about incidents of theft and vandalism that have mounted up, but they have not been investigated.

Police reports are biased and written in the favor of other parties, when I have not been at fault. When I file a report or defend myself against the organized stalkers and their set-ups, I am treated as the perpetrator by the police, even though I have been victimized. This has occurred multiple times. I, along with others in CA, were asked to submit organized stalking statements to the FBI in Southern California, and there was supposed to be an agent assigned to our cases. I submitted my statement in Northern California and asked them to forward it to the FBI office in Southern California. I have not heard back.

Have you moved because of coordinated stalking?

I have moved multiple times, including to another state, but the organized stalking proceeded there, and resumed when I moved back to California.

Have you been mis-diagnosed by mental health professionals?

Yes I was diagnosed with anxiety and depression. I believed them for the first few years, but when I stopped taking the prescribed medication, I realized that I do not need it. I do not have depression or anxiety, nor am I mentally ill. I am just dealing with the harassment from organized stalkers who use plausible deniability to get away with the crimes they are committing everyday against innocent men, women and children.

Resulting effects on your life:

I feel there is no privacy in my life. My phone calls are monitored and my computer is hacked. I do not receive some emails, text messages or calls. Judging by the way my co-workers and others act or things they say, I know there is a smear campaign that goes on behind my back. I have heard their comments and am isolated from all new relationships and old friends. I believe the organized stalkers got to my wife and caused the destruction of my family, including a divorce, which has affected my 2 little girls. I have to constantly repair or purchase items for my vandalized car, house, work van and equipment. The vandalism occurs at a very abnormally frequent rate. My car and house get broken into at will even with alarms on. There is so much more. I don't have anyone to turn to for help. Thank you for your time.

Date: 09/02/2019

First Name: [REDACTED]

Last Name: [REDACTED]

City: Walnut Creek

US States: CA

Zip: 94596

Have you experienced coordinated stalking?

I experience organized stalking at my place of employment, around my residence, in shopping centers, grocery stores, restaurants, hospitals, and the church parking lots. Multiple vehicles parked near my car have their lights on or blinking. There are times when I hear knocking sounds coming from the wall of my next door neighbor or the ceiling from the neighbor upstairs in my apartment building. I have to be cautious who to allow to make repairs to my vehicle because the last time repairs were made to my radiator hose, it came loose after a couple of days. I have been tailgated on the road and mobbed at my workplace. I've also experienced street harassment and color coordinated mobbing by organized stalkers.

Have you reported coordinated stalking to law enforcement?

Yes, I twice have reported my experience to the Walnut Creek Police Department, once in person and then on the phone. Both times my complaint was ignored and no report filed. I recorded the times and dates I tried to file the reports, but due to frustration, I must have misplaced them.

Have you moved because of coordinated stalking?

Yes, we moved from Bay Point, CA to Walnut Creek, CA. We thought things would be different because of a better neighborhood, but the harassment and stalking continues there, too

Have you been mis-diagnosed by mental health professionals?

They did not prescribe me any medication, but thought I was delusional.

Resulting effects on your life:

The stress I experience has immensely affected my career, family and life, overall. I lost my previous job because of organized stalking and harassment. I am lucky to have a job at the present moment and I will try to hang on as long as I can!

Date: 09/03/2019

First Name: [REDACTED]

Last Name: [REDACTED]

City: Oakland

US States: CA

Zip: 94608

Have you experienced coordinated stalking?

Yes. I have been stalked since 2016 by a group of 10 people whom I knew through college networks before the stalking began. This small group, the [REDACTED] is cultish and zealous in its orientation. The group has eight members and two benefactors that are parents to three of the group members.

Have you reported coordinated stalking to law enforcement?

I reported the crime to the Oakland Police Department and filed a motion for protective order with the Alameda County Court. I also requested legal assistance from the Legal Aid Society at UC Hastings law clinic.

Have you moved because of coordinated stalking?

I was forced to move to Florida because of the stalking. I have family there. It was part of the stalkers' plan to "control and direct" the course of my personal life and career, in accordance with what they have called their "prophecy" for my life. In truth, I believe that my move was forced because they wanted to punish me by taking away my networks, relationships and deep commitment to the state of California and the San Francisco, Bay Area.

Have you been mis-diagnosed by mental health professionals?

N/A

Resulting effects on your life:

The resulting impact on my life from organized stalking has been simply devastating. I lost my partner of five years, my job as the Director at a San Francisco based consulting firm and I struggle financially. I became distant or estranged for some time from many of my closest friends and family members, as well as the most important networks in my personal and professional life, including my ties to the alumni communities of Morehouse College, Harvard University, Teach For America, and the Echoing Green Global Public Service Fellowship.

Date: 09/03/2019

First Name: [REDACTED]

Last Name: [REDACTED]

City: Campbell

US States: CA

Zip: 95008

Have you experienced coordinated stalking?

Yes, I have been stalked, verbally assaulted and harassed by co-worker and neighbors. I was placed under surveillance and watched. My health and well-being is affected and daily life is constantly interrupted. I have had money stolen from my accounts. The harassers use numbers, colors and audio to confuse and abuse the mind and soul. They are at every location I visit, especially if I plan going there in advance. They use scare tactics to keep me in fear of my life 24/7.

Have you reported coordinated stalking to law enforcement?

No.

Have you moved because of coordinated stalking?

Yes. I cannot even count how many times I've moved, but they use illegal surveillance wherever I go. Currently my home WiFi indicates a "surveillance van" and "NSA" is in my vicinity. It's either to frighten me or it is real. I am not a criminal and I am a legal US citizen.

Have you been mis-diagnosed by mental health professionals?

Yes. They want me to lose all credibility.

Resulting effects on your life:

They do not want me to experience joy in this life. They haven taken away every single one of my rights as a US citizen and they have stalked and harassed my family as well. I believe they have possibly taken the life of my dog and my mother. Life liberty and the pursuit of happiness does not exist for me here. I am a victim of a hate crime that is inhumane and horrendous, and I don't know what to do except my best, and to have hope each day and faith that justice will prevail.

Date: 09/03/2019

First Name: [REDACTED]

Last Name: [REDACTED]

City: Modesto

US States: CA

Zip: 95355

Have you experienced coordinated stalking?

I have been followed and harassed while driving. I know this has been done in the past and continues to this day. It's a danger to the community when these people drive erratically in a coordinated effort to distract me while I'm driving to cause an accident. I have experienced people in cars purposely cutting me off, boxing me in, attempting to make it look like they want to drive into me and harass me by tailgating. Not only is coordinated stalking dangerous to the person being stalked, but this is an extremely dangerous activity that harms the community as a whole.

Have you reported coordinated stalking to law enforcement?

I have not reported the crimes committed against me to the local police department out of fear, as I am constantly threatened. I have contacted the FBI in an attempt to try to get help. In explaining my experiences, I was practically laughed at. I was told that a report would be filed and only if it was warranted would they follow up with me. They did not follow-up with me.

Have you moved because of coordinated stalking?

Not as of yet.

Have you been mis-diagnosed by mental health professionals?

In an effort to get help and assistance from the medical community, which I didn't get, I have been diagnosed with severe depression and paranoia. This diagnosis is unfounded and incorrect.

Resulting effects on your life:

I can no longer trust anyone. This is no way for anyone to live when you are unable to live your life as you want. I'm unable to travel to any destination freely, without being followed, harassed or threatened. I am not a movie star nor a celebrity. I am not anyone (a regular person?) who has purposefully chosen a life away from that kind of attention. I am a private citizen who just wants to live her life freely, as everyone else in this country, born with rights. These rights have been stolen from me. I have been living in a prison without walls, where the only way out is to kill yourself because there is no way to make this stop. They refuse to stop.

Date: 09/04/2019

First Name: [REDACTED]

Last Name: [REDACTED]

City: Redding

US States: CA

Zip: 96002

Have you experienced coordinated stalking?

The coordinated stalking started a few months after my mother passed away. My neighbor began appearing at the mobile home park where we both reside, the clubhouse where we live, the small market outside the premises, and the Dollar Tree store. Since these are public places it could be explained away as mere coincidence. Then, as I backed out of my drive-way, I began noticing some of my immediate neighbors backing out of their drive-ways at the same time. A small caravan of cars would form in front of my vehicle to escort me out of the park. I soon realized that this is a coordinated effort to make me aware that I am being followed and that the perpetrators are able to communicate with each other to work as a unit. I notice people and vehicles placed in such locations at the shopping centers and malls, as to make it difficult for me to maneuver my vehicle upon entering or leaving. I am constantly blocked. Since my organized stalking started, I may now not always have a caravan of cars escorting me as I leave or enter the park, however, there is always one or two vehicles. The frequency with which this happens cannot be chalked up as mere coincidence.

Have you reported coordinated stalking to law enforcement?

N/A

Have you moved because of coordinated stalking?

I originally moved from Hawaii and kept moving because I thought that if I changed locations the problems would dissipate, but they only escalated with each new residence. I move five times within a five year period.

Have you been mis-diagnosed by mental health professionals?

N/A

Resulting effects on your life:

There is not a single aspect of my life that I feel free to live, as I'm constantly being attacked and slandered. It has a way of permeating your whole life.

Date: 09/04/2019

First Name: [REDACTED]

Last Name: [REDACTED]

City: Lemoore

US States: CA

Zip: 93245

Have you experienced coordinated stalking?

Yes. Beginning in Monterey County, to Salinas CA, Kings County, and Lemoore, CA

Have you reported coordinated stalking to law enforcement?

Indicted in January of 2000 Northern District Federal Courts, Salinas Police Officers / FBI agents were well aware of the problem.

Have you moved because of coordinated stalking?

Yes, from Salinas CA to Lemoore CA , however, the organized stalking followed me and even more people began to stalk me.

Have you been mis-diagnosed by mental health professionals?

Yes, possibly with PTSD or dream disorder, however, my bizarre reporting would prove them wrong.

Resulting effects on your life:

My life became a living nightmare, a battle through hell, and it continues to date.

Date: 09/05/2019

First Name: [REDACTED]

Last Name: [REDACTED]

City: Los Angeles

US States: CA

Zip: 90057

Have you experienced coordinated stalking?

First I'd like to start by stating that this nightmare I am experiencing is against everything good. The coordinated stalking and harassment is sick and unconditional. I've been dealing with being opted into this crime against my will, as everyone else has.

All of my phones have been traced and hacked, my accounts monitored and my life ruined due to organized stalking. There are many people participating against us to break our spirits and relationships.

Have you reported coordinated stalking to law enforcement?

No, I have not.

Have you moved because of coordinated stalking?

No, as I do not have the money to move, but I would like to very soon

Have you been mis-diagnosed by mental health professionals?

No, as I was smart enough to learn from other victims not to share information that would make me look crazy or speak about this to the wrong people.

Resulting effects on your life:

I cannot live a normal life. Every time I go outside, people know who I am and I'm stalked by my community. I believe they can get paid to stalk me, which makes it very uncomfortable for me to leave my home and live a normal life.

Date: August 27, 2019

Your Full Name: [REDACTED]

City: Murrieta

Zip Code: 92563

Please write a brief summary of your experience with coordinated stalking only.

Since 2004, a vindictive former employer has been stalking and tracking me using many electronic stalking tools. I was never close to the man, and kept my distance while I was his employee because his behavior was off the wall and I felt an air of contempt and ridicule in his demeanor when we were in the office together. I believe he is stalking me as a way to inflict emotional damage or perhaps to become adept at new technology as it comes onto the market. I also believe my former boss has recruited friends or associates to help him at times. It was a kind of sick entertainment for them. I think my former employer picked me as target practice. I didn't do anything to him.

A computer repair company owner found a keystroke logger and viruses on my computer. His report stated that there were hacking programs and my computer was being monitored and controlled remotely. I changed my phone number three times in a month due to cell phone harassment. A private investigator detected a digital signal at my home commonly emitted by certain mobile tracking devices. He said that his own cell phone began to exhibit the same symptoms I had previously reported. It would power on and off and his calls became interrupted. He was forced to discard that phone.

Please describe your experience if/when you reported the crimes to law enforcement.

I initially reported suspicions of being organized stalked to Murrieta police department in September 2004, but they didn't believe me. I gave the name, age, address and other information about my suspected stalker to Murrieta police in a November 2004 report. That cellular phone tapping report was followed by a vandalism report about a month later in which I also named my former boss as a suspect.

Please describe your experience of being misdiagnosed by mental health professionals if applicable.

I was ordered to undergo a 72-hour mental health observation in January 2005. That was ordered after I fired a gun into the ceiling. I suspected an intruder when I heard someone walking on the roof. I started seeing a therapist who was initially skeptical of my claims and said they could be written off as delusional or psychotic. During our first interview, he also thought I may be bipolar.

Please tell us if you moved due to the stalking.

I moved from Idaho to California to escape organized stalking. In total, I moved nine times in two and a half years.

Please briefly describe the resulting effects upon your life:

I had to stop using nearly 60 cell phones because they were hacked in succession. I also sold or traded several vehicles because I suspected they were equipped with GPS or listening devices. The harassment and repeated stalking affected my livelihood, put a serious strain on finances and I ended up selling my house in July 2005, resulting in losing almost everything I cherished.

Date: September 8, 2019

First Name: [REDACTED]

Last Name: [REDACTED]

City: Lake Shasta

US States: CA

Zip: 96079

In Statement... I [REDACTED] of sound mind do tell the truth. I bear witness to overt and/or covert smear campaigns and gang stalking programs and street harassment.

Date: September 10, 2019

First Name: [REDACTED]

Last Name: [REDACTED]

City: Sacramento

US States: CA

Zip:

My name is [REDACTED] people call me [REDACTED]

One day on my way home I saw I was being followed. I thought they were some kind of police force. Since I didn't have anything to hide, I thought they would do their investigations and then leave me alone. As time went by I saw they were not only going away but also their harassment increased. Everywhere I go they follow me and people then started to treat me differently at work and in my neighborhood, at the stores and in school. I started to isolate myself by not going anywhere unless I absolutely have to. As a result of the harassment at work, I had to quit my job and hide at home. That was when things got worse. I was alone and had nobody to turn to for help or support. They obviously have done serious character assassination, causing me public humiliation.

I have experienced multiple persons stalking me in a coordinated fashion. I didn't know what to do so I started hiding behind alcohol (I was terrified). For a little while I thought it had ended. I met a wonderful woman, quit drinking, got a job and again created a good life for myself. One day they all came back. My beautiful wife noticed and said she was seeing little guys with black suits like ninjas and were being followed everywhere. My wife got sick from the stress of it all. She began to deny knowing what was happening. She was terrified and sick all the time and in 2017 she had abdominal surgery. Even though it was a simple surgery, it didn't go well. She got an infection and did not survive. The paramedic announced the cause of death was high blood pressure and alcohol, and I am still being followed all the time. I feel like a human guinea pig. Thank You

Date: 09/08/2019

First Name: [REDACTED]

Last Name: [REDACTED]

City: Bakersfield

US States: CA

Zip: 93304

Have you experienced coordinated stalking?

My family and I are suffering from the torture of coordinated stalking and harassment. This is the most criminal act in the state of California and the United States. My family and I have suffered assaults, property invasion, car sabotage, verbal attacks, transgressions on my personal life as well as on our social security numbers, bank accounts and passports. They have distributed my picture, my family's personal information, my license plate number, and wired and incapacitated my vehicle. These perpetrators have also posted my personal information on social websites, hacked and interfered with the use of my cellphone and computer. Participants include my co-workers, neighbors and other community based stalkers.

Myself and my family's lives have been disrupted. We are forced to alter our work hours and make repeated doctor visits, who don't understand our symptoms. Our communication with friends and loved ones has also been affected. Everything my family and I do, where we go and who we associate with is monitored by implementing the use of video cameras, speakers, amplifiers, and other audio equipment.

The stalkers and their associates change their cars on a daily basis. They use electronic equipment that emits flashing lights and something else that we think are radio waves. They also send signals with high beam lights when I get close to work or drive home. They've been observed communicating with radio transmitters, cellphones and walkie-talkies. When they use audio equipment to coordinate their harassment, I've overheard them giving instructions to other stalkers in their group. There have been incidents while I was working alone or overtime when I was surrounded by 10-15 vehicles. As I conclude this plea, Senator, on behalf of my parents, brother and myself, I ask that you please stop these attacks which cause such severe emotional and physical impairments and suffering. We are asking you to provide assist in terminating these inhumane practices which affect so many wonderful people.

Have you reported coordinated stalking to law enforcement?

On January 24, 2015 I report the sabotage of car. The alarm on my car has been remotely triggered on and off. Vehicles wring my license plate, and try to enter to my house.

On January 23 and 26 of 2016 I reported this harassment, however nothing was done.

In 2016 I sent a letter to Senator Feinstein

On October 3, 2017 I reported harassment to Sacramento State.

On June 31, 2018 I filed a police report. I have also sent a letter to Senator Clinton in 2018 and the U.S. President in January 2019.

Have you moved because of coordinated stalking?

Yes, but the stalking and harassment have not ceased.

Have you been mis-diagnosed by mental health professionals?

Never. However, my doctor advised me to file a police report.

Resulting effects on your life:

I live in constant state of fear. I never know when and how these people will attack me and my family. My parent are very ill because of this situation; they have been hospitalized. I fear for my own and my parent's lives. I don't even have the privacy to speak to friends and family because they listen to all my conversations and have let me know that they can see everything. I am concerned about our security and freedom.

Date: 09/08/2019

First Name: [REDACTED]

Last Name: [REDACTED]

City: Fullerton

US States: CA

Zip: 92831

Have you experienced coordinated stalking?

I experience coordinated stalking by multiple strangers 7 days a week, every time I leave my house. It is highly organized and creates problems for me every day. I drive for a living and the coordinated stalking makes my job much more difficult than it would normally be. On the road cars drive into my lane in an attempt to cause an accident. Strangers park their cars in the front and back of my house and down the street, waiting for me to leave my home. This occurs 7 days a week.

Have you reported coordinated stalking to law enforcement?

I went to the police station twice, but they wouldn't even file a report and they didn't seem to care. I also called the FBI twice. The first time they took a report, but the second time they informed me that they don't get involved with these types of complaints.

Have you moved because of coordinated stalking?

I have not moved because of the stalking. It's highly organized and involves so much manpower that I'm certain it would just follow me to a new location.

Have you been mis-diagnosed by mental health professionals?

I have never been to a mental hospital or been diagnosed with a mental illness. I haven't taken medication for mental illness, depression or an anxiety disorder. Coordinated stalking began when I was in my 50's. I know myself well and that my experience is not due to a mental disorder.

Resulting effects on your life:

The highly organized stalking has taken over my entire life. When I visit my 95 year old mother or any other family member, I am stalked and followed. This type of stalking prevents people from going to work and causes them to lose jobs. I have met many people in Orange County and L.A County areas who are having this exact same problem.

Date: 09/08/2019

First Name: [REDACTED]

Last Name: [REDACTED]

City: San Jose

US States: CA

Zip: 95112l

Have you experienced coordinated stalking?

I've experienced moderate to occasional coordinated stalking by multiple persons for 47 years. All of the following examples have been and/or are presently being done to me. None are impossible or even difficult to execute (labor intensive, yes). What's impossible is to get anyone to believe that any of this is going on. My life has changed drastically. Up until this started, my life was normal, but this is no longer so.

My life became filled with inexplicable annoyances and a changed, strange demeanor in other people. Blatant or subtle, these things are noticeable. One does not plan or expect to notice them. If it's there, it's noticed. Since the same type of events were happening over and over, it became obvious that someone was causing this. Initially, I'd see a half a dozen people who were often around me, but these days there seems to be an infinite supply of these strangers stalking me. I've become skilled at picking them out when I'm out and about.

Now my closest neighbors are all involved as well. Everyone experiences annoyances - major and minor ones. There are a million things that happen and any one of them may occur at any time. But how often does one of these things occur in a person's life? Once a day? Once a week? Enough to become a major part of one's life? No, but for me it does. There are millions of ways to annoy someone, and noise is probably the easiest. One's home is no longer a refuge. Noise, knocking on the walls, clicks, snaps, etc. that deprive me of sleep. Random neighbors help with the harassment.

Odors are often used. All manner of usually pleasing or enticing scents are commonly found in peoples' lives. But someone manufactures strange, indescribable odors for the purpose of harassment. Lingering or transitory, strong or subtle, mild or overwhelming, they appear in my apartment or car, on clothing, my body, breath or hair, anywhere at anytime. These scents don't dissipate like regular odors/fragrances.

I have long known that there are cameras in my apartment. I can't find them, but in recent times I've had proof of sorts, but items can be wiped off my hard drive and any other form of proof can be discovered and stolen. Breaking and entering into my apartment and car occur at will and my phone is tapped and computer hacked. They go through my garbage, too. There were two periods of time when my cat's behavior was affected, and then a longer period of time when I believe my cat was suffering.

Have you reported coordinated stalking to law enforcement?

No

Have you moved because of coordinated stalking?

No

Have you been mis-diagnosed by mental health professionals?

I saw a psychiatrist to explain and convince her that I was truly being harassed. But she just said that I wasn't and that I was a schizophrenic.

Resulting effects on your life:

I have many stress-filled hours, and I just weather it. When the stalking and harassment was dormant everything was cool, but then when it started up again I attempted suicide. A website explained that pills were good for suicide, but it is not so. A doctor told me they were more or less "user friendly." I no longer feel suicidal, it kind of went away. Now I feel a little like a 3rd party observing what people are doing. My neighbors somehow think they're doing a good thing.

Date: 09/07/2019

First Name: [REDACTED]

Last Name: [REDACTED]

City: Yucca Valley

US States: CA

Zip: 92284

Have you experienced coordinated stalking?

Yes, coordinated stalking was the initial harassment I perceived.

Have you reported coordinated stalking to law enforcement?

On April 30, 2015 a group of people, including myself, who also victims of coordinated stalking, went to the FBI headquarters in New York, at 26 Federal Plaza. We filed a report and each got a copy of our individual complaint relating to coordinated stalking and other harassments. Unfortunately, we did not get a follow up from the FBI.

Have you moved because of coordinated stalking?

Yes, and the crimes are much worse in populated cities. The environment around the person is used to keep them distracted and in a constant state of anticipation.

Have you been mis-diagnosed by mental health professionals?

I was misdiagnosed with delusional disorder and schizophrenia. I told the therapist the truth, that I am being stalked and harassed by my family, friends, neighbors, co-workers, and strangers.

Resulting effects on your life:

All the effects and symptoms, psychological and physical, are detrimental to me. I suffer from chronic depression, compartmentalization, degradation of memory, poor attention and learning skills. I became aware of the harassments at 18 years old, before my brain even completely developed, and I've been held back from leading a normal life. I was living in an over populated city of 8 million people. I was uneducated, young, stupid, and living in poverty while being subjected to the worst form of stalking and harassment. I've been deprived of life and liberty and tortured since my teenage years. I do not know as of yet if I have sustained permanent brain damage from this horrific experience.

Date: 09/07/2019

First Name: [REDACTED]

Last Name: [REDACTED]

City: Clovis

US States: CA

Zip: 93612

Have you experienced coordinated stalking?

After moving to a low income affordable housing apartment complex I immediately became targeted and stalked by the property management owners [REDACTED]. It has been ongoing for years.

Have you reported coordinated stalking to law enforcement?

No, because when I attempted to, I was treated as though I was crazy. The San Luis Obispo District Attorney's office said, "You will never prove that everyone is involved!"

Have you moved because of coordinated stalking?

Yes. I moved to Clovis, California. I have a great deal of respect for the local Clovis PD.

Have you been mis-diagnosed by mental health professionals?

I was diagnosed with borderline personality disorder and paranoia and put on Resperidol. My son was taken from me by San Luis Obispo CPS due to my complaints of environmental injuries and ongoing financial crimes.

Resulting effects on your life:

I've been a victim of coordinated stalking and harassment for years and I'm now in my 60s, and there isn't much left of my life. My special needs son is also a victim and severely injured, and he will never live a normal life.

Date: 09/06/2019

First Name: [REDACTED]

Last Name: [REDACTED]

City: Poway

US States: CA

Zip: 92064

Have you experienced coordinated stalking?

I have been a box-in victim while driving. I am harassed at stores by coordinated stalkers — strangers who I do not know — crowding, blocking and sometimes even bumping me. I'm also harassed at my child's school and parks. Parents and kids use hand signals to notify each other where I am. Cars park very close to mine not leaving me enough room, while there are no other cars around and plenty of parking spots.

Have you reported coordinated stalking to law enforcement?

No

Have you moved because of coordinated stalking?

Yes, but nothing has changed.

Have you been mis-diagnosed by mental health professionals?

No

Resulting effects on your life:

I have been dealing with coordinated stalking and harassment for years. At first I tried to fix it, but nothing worked, so I kept silent. I am an average, good person who loves God, and there is no reason for these types of crimes to happen to anybody, but especially good, God fearing citizens.

Date: 09/06/2019

First Name: [REDACTED]

Last Name: [REDACTED]

City: Long Beach

US States: CA

Zip: 90815

Have you experienced coordinated stalking?

My coordinated stalking started in 2011 in West Hollywood, CA. I was stalked by several neighbors at my apartment complex at [REDACTED] West Hollywood, CA. I lived at that complex for 25 years without any problems until the last several years when extreme xenophobia and racism started building up. I didn't associate with the new neighbors, who gave me bad vibes. Most of them were meth junkies and extreme alcoholics who were deadbeats and unemployed. This was all later attributed as "Post 9/11 Syndrome" and I, being an Indian-Muslim, became a perfect victim. Harassment ensued via projected and directed conversations. I complained to the landlord, and what ensued after that was full-on bullying and even more harassment. They were trying to convince the new neighbors that I was a terrorist. Those who can't control you will control the way others see you. They were gaslighting me by saying that I was crazy and that nothing happened and it was all my imagination, instilling in me self-doubts. They were experts in pure gaslighting and extreme narcissism. It became so bad, that after 25 years I had to vacate my residence. I moved a few blocks away, as I wanted to stay in West Hollywood, CA. Several months later, they restarted the stalking campaign and influenced my neighbors at the new location. They, too, banded together to get me "out". What followed was highly organized community stalking, all because I was a person of a certain race who was standing up to them. I briefly became homeless after that. Since then, I experience coordinated stalking by strangers everywhere I go. At train stations I am being pushed from the back, hence, street harassment. At the grocery store my cart was taken away while I was not looking and conveniently placed outside, making it appear that I was stealing and running away with the goods. The stalkers hang out outside the stores at the malls using their earphones and cell phones to track my whereabouts. It continues to this day.

Have you reported coordinated stalking to law enforcement?:

Not in so much detail. After I moved from N. Laurel Avenue to N. Hayworth Avenue, I filed two reports of harassment with the West Hollywood Sheriff when the perpetrators were flashing camera-flashes at my window in an attempt to intimidate me. The officers came and took down my information, but there was no real follow-up as I was driven out of there.

Have you moved because of coordinated stalking?

To date, I have moved at least 9 times since 2011. That includes living in motels, with friends and at the community housing shelters.

Have you been mis-diagnosed by mental health professionals?

I have not been misdiagnosed as of yet, though I have received medication to help me sleep better when I experience sleep deprivation due to stress. My counselors here are well aware of coordinated stalking and they are believers, but they still have to treat it as a sleep disorder.

Resulting effects on your life:

I have been on disability for almost 5 years and before that on GR. Additionally, I'm pretty much isolated from family and friends and I'm unemployed. I have weight loss, sleep deprivation and have lost my hearing.

Date: 09/05/2019
First Name: [REDACTED]
Last Name: [REDACTED]
City: San Francisco
US States: CA
Zip: 94102

Have you experienced coordinated stalking?

I have been a victim of overt coordinated stalking since the Fall of 2018. This stalking and harassment occurs in my apartment building, in and around my neighborhood, on public transportation, and at San Francisco State University where I am in the process of completing a bachelor's degree in economics.

The ongoing inhumane behavior I am experiencing includes, but is not limited to, the following:

- Slander campaigns
- Illegal Surveillance (Audio and Video)
- Hacking devices (using personal information against victim)
- GPS tracking
- Intercepting communications
- Tailing on foot and in vehicles
- Noise campaigns
- Online harassment
- Road bullying

Have you reported coordinated stalking to law enforcement?:

I attempted to seek remedy and counsel by reporting the harassment to the Mission police DPT in San Francisco. While the officers were pleasant there was no attempt made to file a formal report. The experience created a diminished level of confidence in the police to assist me with this issue. I have not made a second attempt to report these crimes.

Have you moved because of coordinated stalking?

I attend San Francisco State University full time. I do not have the financial means to move. I also do not believe moving would stop the harassment. I have had to endure these consistent and ongoing abuses in San Francisco, surrounding counties and in other states when traveling.

Have you been mis-diagnosed by mental health professionals?

I have not been misdiagnosed by a health professional. I have been offered medication for the anxiety that these attacks can create, but have chosen not to take such measures.

Resulting effects on your life:

This issue has robbed me of the peaceful enjoyment of my home. The effects have made the task of earning a college degree exponentially more difficult. Though I choose to be positive and find joy in each day, I would be less than honest if I did not admit the intense emotional toll that this ongoing experience has exacted on my quality of life. The mental effort required to study, take a walk, go grocery shopping and the other normal daily tasks in the midst of the daily barrage of harassment is immense. No one deserves to go through this. We need legislators to stand with California citizens to stop these crimes. Crimes that are affecting our communities at an ever-increasing rate. Please help stop the degradation of our state by these abuses.

Date: 09/05/2019

First Name: [REDACTED]

Last Name: [REDACTED]

City: Boulder Creek

US States: CA

Zip: 95006

Have you experienced coordinated stalking?

I experience work mobbing, community whisper campaigns (slander, derision and character assassination), theft, vandalism, idle threats muttered in various public retail locations, ostracizing by community, family and friends.

Have you reported coordinated stalking to law enforcement?

No

Have you moved because of coordinated stalking?

Yes. I'm presently moving out of state after five generations of family history and 50 years of personal experience in California.

Have you been mis-diagnosed by mental health professionals?

No

Resulting effects on your life

Isolation, bitterness, anger, volatility, exclusiveness and so on.

Date: 09/09/2019

First Name: [REDACTED]

Last Name: [REDACTED]

City: Porter Ranch

US States: CA

Zip:91326

Have you experienced coordinated stalking?

I've experienced coordinated stalking, that I'm aware of perpetrated by my neighbors and family. I used to assume everyone, including my family and friends, knew what was happening to me, and I couldn't understand how these people I knew so well could do this to me, as this experience has been so painful.

Have you reported coordinated stalking to law enforcement?:

No. I once called and left a message, but then for fear that my daughter would be taken away from me if they didn't believe, I never returned their call.

Have you moved because of coordinated stalking?

Yes, I was so hurt initially and wanted to make it stop, so I moved across country to get away from friends and family who I thought were knowingly participating in the stalking and harassment. Then, feeling isolated around friends who were participating, I moved again to be closer to my family. But, it doesn't get any better anywhere I go. I recently moved again from California to Hawaii because I read the control can be less severe on an island, but it isn't. It's all the same harassment and psychological abuse. And it extends to people working for companies where I apply for jobs. They are manipulated into sabotaging any effort I make to make a living. This has been ongoing for years, making it impossible for me to financially support myself and my family.

Have you been mis-diagnosed by mental health professionals?

No, but when I spoke to my daughter's doctor, I was so upset and distraught that her doctor called social services on me, but it resulted in the claim having no basis. I also tried to talk to a reverend once. The day I went to speak to the reverend, she said she had a dead rat under her office, so I got scared taking this as a subliminal threat on my life and never spoke to her again. The threats are constant as a way to manipulate everything I do or want to do.

Resulting effects on your life:

The effects on my life are living in a constant state of fear and anxiety with all the threats, abusive disruptions to my life with my daughter, not being able to financially support myself, the pain and agony of my poor innocent child, as well as the pain and agony of very few people believing me. My own mother calls me delusional. It's a nightmare that affects our life and physical and emotional well being.

Date: 09/09/2019

First Name: [REDACTED]

Last Name: [REDACTED]

City: San Diego

US States: CA

Zip: 92116

Have you experienced coordinated stalking?

The day I realized and became hyper-aware that something was going on with me, was May 19, 2018, which was Armed Forces Day. Since that day I have experienced a lot of what I call "street harassment" or just people in public who I do not know acting much different from what I would call "normal".

Many times there are white vehicles tailing and following me to certain destinations, waiting outside my place or in the parking lots of places I go to. I've had people pointing their cell phones at me to take videos or pictures. This also happened at my doctor's office when one of the nurses came up and took a picture of me. Sometimes people with professional cameras come up to me and take my photo. Once, everyone inside a beauty store (15 people or more) were all filming me on their phones, which was the scariest experience ever. Strangers come onto my property and take pictures of my home. People invade my personal space when I'm in checkout lines or shopping. White vehicles follow me around town and try to run me off the road to cause an accident, or they chase me to a dead end street and block me from turning around and escaping.

When I lived at a complex at [REDACTED] San Diego, CA 92116 from August 2018-July 2019, a bunch of people there would exit or enter whenever I went outside. When I went on a walk, they all came out of their houses to intimidate me and prevent me from enjoying myself. Personal items such as clothes, phones and money were either stolen, moved, planted, or destroyed in my apartment. I found items in the refrigerator, underneath my kitchen sink and inside a cleaning bucket. My mail began disappearing or it wasn't delivered at all.

My Facebook, Gmail and others online accounts were hacked, and some I have not been able to recover due to password changes made by I don't know who.

Also, my food had been tampered with and I got sick. I also believe that I've possibly been drugged because many times I would feel completely normal and then suddenly become sleepy and pass out or blackout. One such scary experience occurred when I was woken up in my car by a police officer. I had "fallen asleep" at the wheel with a two-year old in the car with me, whom I was talking home. I had strapped the baby in his car seat and then myself got in the driver's seat. The next thing I knew I was being awakened by two police officers. They harassed me for about 20 minutes, making fun of my appearance and the shoes I was wearing, and then they just left . It was a horrible and embarrassing experience. I still don't know what happened to me that night, but I do know I was not too tired to drive, otherwise I would never have attempted to take the kid I was watching home. I would have waited. I would later meet one of the police officers again when I was falsely arrested. He was the officer waiting to put me in his car. At that time I had a panic attack and instead was taken to the hospital.

I was later put into jail for two days for an alleged crime completely irrelevant to what I was initially being detained for, which was related to a domestic violence charge after I had thrown a lotion bottle cap at my partner. But that occurred after my partner had left the apartment, so I actually never pointed it anywhere near him. The police were just using anything they could to put me into the system, and unfortunately, I gave them a reason.

Have you reported coordinated stalking to law enforcement?

I did try to report the internet hacking crimes to the DOJ and FBI in September of 2018, but nothing was ever done and they didn't even respond.

Have you moved because of coordinated stalking?

Yes, I moved to Tucson, AZ in July of 2019 and this was not by choice. I feel the people in the neighborhood I live in now are also behaving strange.

Have you been mis-diagnosed by mental health professionals?

I have not gone to see a psychiatrist out of fear of being misdiagnosed. My doctor has prescribed me an antidepressant, but it didn't work.

Resulting effects on your life:

My life is completely in pieces. I don't have any friends any more, or a car or a job and I don't receive any help. Nobody believes me. I am tired and worn out to the point of wanting to die everyday. I have been seriously considering suicide for the last six months.

Date: 09/09/2019

First Name: [REDACTED]

Last Name: [REDACTED]

City: San Diego

US States: CA

Zip: 92116

Have you experienced coordinated stalking?

The day I realized something was going on with me and became hyper aware was May 19, 2018 which was Armed Forces Day I later realized . Not sure if that has any relevance or not but I thought it was quite ironic. I have experienced since this day a lot of what I call "street theater" or people just acting much different than what I would call "normal". I had white vehicles sometimes tailing me and following me to certain destinations, or waiting outside my place or waiting in parking lots of destinations I would go to. I had people pointing their cell phones at me and video or taking pictures of me . This also happened at my doctors office one of the nurses came up and took a pic of me . Sometimes I had people with professional cameras come up to me and take my photo. I had about everyone (15 people or more) inside a beauty store once all filming me on their phones which was the scariest thing ever . Strangers would come into my property and take pictures of my home . people would invade my personal space when in line at checkouts or shopping. White vehicles would chase me around town and try to run me off the road to get into accidents or they would chase me to a dead end and then block me from turning around to escape. I was always getting dirty looks and unfriendliness or I would completely be ignored . I had what seemed like a bunch of the people who lived in my complex at [REDACTED] San Diego , ca 92116 where I lived from Aug 2018-July 2019. They would do same time exit or entry of when I would go outside. If I would try to go on a walk they would all come out of their houses to intimidate me from enjoying myself . I was having things inside my apt destroyed or stolen like clothes , phones or money. Objects were being placed in places I did not put them . Such as the refrigerator or underneath my kitchen sink inside cleaning buckets buried . My mail started disappearing or just not be delivered at all. I had my online accounts all hacked like Facebook, gmail, etc. some of which I have not been able to recover due to password changes done by stalker. Also I have Had my food tampered with so I was sick to the point of being bed ridden for weeks. And possibly drugged because I have had so many times I would be completely normal and then all of the sudden I would become so sleepy I would pass out and blackout. One experience that was very scary was when I was woken up by a police officer in my car when I had "fallen asleep at the wheel" and I had a 2 yr old in the car with me who I was taking home I had strapped the baby in his car seat and got in the drivers seat and next thing I knew I was being woken up by a police officer 2 actually , and they just harassed me for about 20 mins making fun of my appearance and the shoes I was wearing etc and then they just left . it was horrible I felt so embarrassed . I still don't know what happened to me that night but I do know I was not too tired to drive otherwise I would of never attempted to take the kid I was watching home . I would of waited! That same police officer I would later meet again in the future when I was falsely arrested he was the officer waiting for me to be put in his car, which I then had a panic attack from and was instead brought to the hospital but still placed in jail for 2 days and then released for something completely irrelevant to the "crime" they took me in for which was something about domestic violence because I had thrown a bottle cap to a lotion at my partner and because I had a taser that I pressed the button on . But it was after my partner had left the apt already so I never pointed it anywhere near him, they were just using anything they could to get me put into the system and unfortunately I gave them a reason to.

Have you reported coordinated stalking to law enforcement?

I did try to report some of the internet hacking crimes to the DOJ and FBI in September 2018 but nothing was ever done or even responded to by them.

Have you moved because of coordinated stalking?

Yes I moved to Tucson , AZ in July 2019 but this was not by choice and I feel the neighborhood I'm at is also acting strange.

Have you been mis-diagnosed by mental health professionals?

I have not actually went through with seeing a Psychiatrist in fear of being mislabeled. I have been given medication for depression though from doctors. However it never seems to work.

Resulting effects on your life:

My life is completely in pieces . I have zero friends , no job , no car , no help from anyone . No one believes me . I am tired and worn out to the point of wanting to die everyday. I have been considering suicide seriously now for the last 6 months.

Date: 09/10/2019

First Name: [REDACTED]

Last Name: [REDACTED]

City: San Francisco

US States: CA

Zip: 94941

Have you experienced coordinated stalking?

Yes, and initially the stalking began to affect my work until I had to postpone the practice of law to find a solution to the problem.

Multiple individuals will coordinate a series of stressful situations, for a few examples:

- Delaying work, engaging in false rumor campaigns
- Blocking egress/ingress
- Very loud shouting/noises directed towards me
- Overwhelming odors/stinkbombs
- Out of control children or leashless animals being thrust unto contact or very near contact
- Series of Vehicles consistently honking, tailgating, consistently spotlighting with highbeams
- Vehicular assaults (near contact)
- Orchestrated mobbing, crowding, aggression/foul language & physical assaults and battery
- Calling of police/swatting for very minor offenses (low cargo carrier, window tint)
- Calling of police/swatting on false pretense (weapons call for a wood-axe that laid deep in my trunk merited two cruisers on a weapons call)
- People around you will loudly repeat your recent internet searches or concerns
- Break-ins, stealing
- Consistent hacking of phone and cameras right before an attack occurs (i.e. phone set to a reboot mode and at the same time a dash cam would also fail)
- Consistent hacking of computer and phone when using google maps and need a location (i.e. disabling offline maps on two different phones simultaneously)
- Service denial, degradation, and delay (including eating at restaurants, and shopping for groceries)

Have you reported coordinated stalking to law enforcement?

A few years ago, reported a near vehicular assault (car shadowed me in parking lot and nearly ran over my foot) to L.A. Area police. When I stated I was subject to stalking he incredulously replied to the effect of "come on, are you a millionaire?" Apparently it's a crime only when done to rich people.

- A few years before that, I was chased around by several men, at night, probably something like an hour, and over multiple miles. They aggressed, insulted, blocked me from parking, and made gun firing gestures at me. The LAPD police refused a report, and blandly stated that there was obviously no "sustained fear" - not a requirement under the statute.
- A few years before that I was assaulted by a gang of men whose images and license plate were caught on camera. The LAPD failed to follow up, and let the case drop.

Have you moved because of coordinated stalking?

Yes, in fact I used to live near Los Angeles, moved all the way up to the North West Coast of California, and now I am in San Francisco.

Have you been mis-diagnosed by mental health professionals?

None, have not sought their aid with this law enforcement issue.

Resulting effects on your life:

Left the practice of law to prevent harm on my clients and firm. Over the years I have spent my savings and time looking for a solution including looking for a place that didn't have this practice - but it is clear that it is widespread. Hits occurred in Canada and throughout California.

Date: 09/10/2019

First Name: [REDACTED]

Last Name: [REDACTED]

City: Fairfield

US States: CA

Zip: 94533

Have you experienced coordinated stalking?

I have had endless road bullying and sabotage of my automobiles, stolen automobiles, hacking and stealing of several of my phones, they steal my keys, belly packs, wallets, they rob my post office box, storages, home, my church to steal my music equipment and sabotage all means of me being able to support myself, protect myself or defend myself. They shut off my electricity at the fuse box and pound on the house to harass me and when I am gone they break in and steal my belongings, especially if it sabotages any means of supporting myself. They have done severe bank fraud and identity theft, they follow me on foot and steal my backpacks, belly packs, keys and cellphones.

Have you reported coordinated stalking to law enforcement?

I have contacted the FBI and local authorities a number of times and they claim to no nothing about coordinated stalking here in Fairfield, although the FBI scanned me with a wand and said that I have been severely microchipped.

Have you moved because of coordinated stalking?

I'm not moving, I am concerned about others in my community.

Resulting effects on your life:

My life is being totally destroyed, sabotaged. This force is hell bent on seeing that I die a painfully orchestrated downward spiral to homelessness and death with no means of recourse or the ability to defend myself, support my family or help my daughter and grand-daughter. And this is only the tip of the iceberg in the brutality and diabolical extent of criminal sabotage of human life.

Date: 09/10/2019

First Name: [REDACTED]

Last Name: [REDACTED]

City: Petaluma

US States: CA

Zip: 94952

Have you experienced coordinated stalking?

My landlords, “the [REDACTED] family,” were the first hint, that I had a “covert stalking system” in place in my life, when I lived in their basement apartment in Petaluma, California. The [REDACTED] family went from being covert to blatant stalkers when they confessed to spying on me in attempts to blackmail me. Shortly after I informed the Housing Authority that they had not disclosed the health risks of mice living in the walls of my apartment.

On February 1st, 2018, [REDACTED] and his daughter [REDACTED] confessed to my face of illegally spying and investigating me, without my knowledge or consent. [REDACTED] rationalized her family’s undisclosed crime — that aimed at taking advantage of a sickly tenant (such as me) — and thought nothing of exposing me to mice toxins, all the while taking advantage of Section 8 and myself, to pay their reduced monthly mortgage payment of \$600. [REDACTED] explained that they didn’t feel bad not telling me what poisonous toxins and mice contaminations I would be exposed to, because with my tumor present they figured I would die young anyway.

[REDACTED] confessed to the fact that she and her fiancé, (along with the whole family), had been listening to my cell phone conversations, reading my text messages, and emails, along with my private documents inside my laptop computer. She proudly announced to me that she had spent the last six months in full time study of my life. [REDACTED] began to give me vivid details to prove that she had examined every detail of my life. She twisted my life events like a self proclaimed judge, jury and prosecutor to frame me for crimes that were preposterous. For example, she claimed I was a murderer because I had undergone a few abortions. In actuality I had to have abortions to save my own life because my disability didn’t allow my body to carry a child. [REDACTED] additionally mentioned details that could have only been obtained by reading them from my computer. She confessed that they had watched me use the toilet and shower while naked with a camera they had installed in a new fan system in 2017.

During these years my art studio landlord in Petaluma, Ms. [REDACTED] had also been involved with my character defamation. [REDACTED] also stole a prized bronze sculpture I had painfully created, worth anywhere from \$8,000-\$30,000. I suspect she was put up to this crime in order to further destroy me financially and send me into utter depression as a result of losing such an amazing lifetime achievement. Officer Marcus Holmes told me she stole and sold my life size bronze sculpture without my permission. [REDACTED] lied to my face, when I asked where it went, and without remorse told me that she had given it away to a metal collector!

Due, to “the [REDACTED] family’s,” blatant stalking and intensified harassment, including death threats, I was forced to move from their rental unit after the Sonoma fires. Between February 26 and March 12th of 2018, I underwent two frantic and traumatic trips to pack and move from Petaluma, California to Reno, Nevada, where my sister lives. Although I had made several attempts at finding another rental in the Petaluma area, my landlords, (who stalked my computer and phone) went to my potential future landlords and told them lies about my character, so even landlords that liked me upon meeting me changed their mind of renting to me.

Thinking I had found a place of refuge in Reno was a a mistake. My sister [REDACTED] gave me only one place to sleep, and that was along side her 11 year old son on an adjacent mattress on the floor. I was very uncomfortable and confused by these sleeping arrangements. Soon it became clear that her motive was to frame me for pedophile behavior. One night after I had given [REDACTED] a head massage to help him calm down and sleep, she came flying into the room and accused me of making sexual moves on him.

Additionally, [REDACTED] son [REDACTED], age 23, was given a role in my harassment, both on a physical and emotional level, by inflicting violence. On the day we unloaded my stuff into my Reno storage unit he laughingly smashed and threw my fragile things, while yelling and mocking me. His mission wasn’t complete until he stole both my full prescriptions of Norco and Soma. [REDACTED] finished the day by throwing a violent fit and flung my furniture broken onto my sister’s lawn.

My life in Reno, Nevada, continued with more of the same, except that I was alone and susceptible to new harassments including: pranks with private inspectors, apartment managers, apartment inspectors, tenant spies, ex-cops, doctor informants, PT therapist spies, and street harassment, staged by unknown strangers dropping clues of both the covert and blatant harassment at the [REDACTED] family rental unit in Petaluma, California.

Have you reported coordinated stalking to law enforcement?

February 13, 2018: I dialed 911. Officer John, came to my door and documented with his video recorder my story with the [REDACTED] family and their blatant harassment and illegal surveillance. While the officer was present, my phone charged like normal, but the minute he left, the charge stopped. Within a short while, I had no phone to communicate to any one of the dangers I was in at the [REDACTED] apartment. I also had been struggling to repair my car, later learning that my landlords had cut a distributor wire.

I walked a half mile to the Petaluma Police Department to make a second report on the same day. I was made to sit for two hours, until Officer Marcus Holmes from Santa Rosa Sheriffs office came to talk to me. At first, he listened to my landlord's harassment story with belief, but within 5 minutes, he began to accuse me of mental illness and having a vivid imagination.

Officer Holmes, visited the [REDACTED] family for a short while, and then spent the next two hours talking to me. The first hour he spent denying that my landlords were involved with any crimes, then changed his tune the second hour, confirming to me what tricks my landlords had been up to for years. He confessed that they had installed advanced spyware in my apartment, breaking and entering all summer long, snooping through my stuff. He told me they had installed spyware devices in my computers, in my fire alarms, in my bathroom fan, and made videos of me undressing and having sex with my boyfriend.

He informed me that my life in Sonoma County was over after 55 years of being a native. He suggested that I moved to Reno for safety reasons, and that if I tried to get Officer John to testify for me in court, that he would make sure I ended up in jail.

Have you moved because of coordinated stalking?

Yes, I not only moved, but also had to move to another state and city Reno, NV, away from all my friends and my established community.

Have you been mis-diagnosed by mental health professionals?

In California, I was a medically challenged patient dealing with a tumor in addition to joint pain, but had no record of addiction or mental illness. However, when I sought medical help at the ER in Reno after my Norco disappeared, the perpetrators urged my doctors to deem me a drug addict due to my withdrawal from opiates. These accusations, caused false assumptions, that I had a mental disorder. That was a misdiagnoses of my PTSD symptoms.

Without my knowledge the Reno ER doctor prescribed me an anti-depressant drug while I was withdrawing from Norco. These drugs felt addictive and disruptive to my nervous system. I quit the drug after a week. In the following months I continued to suffer from PTSD and my Reno doctors continued to read my symptoms as depression and anxiety, inferring mental instability. My anxiety ended the day I hired a California lawyer for the life altering damages caused by "The [REDACTED] family".

Resulting effects on your life:

I find myself alone in one of the most isolated living conditions I have ever known. I live in a HUD funded senior apartment complex in downtown Reno, with people that are 10-20 years older than myself. The environment is the complete opposite of the Northern California community I have known for 55 years. This city has put a damper on my generally optimistic attitude. I have difficulty finding new friends, in addition to the blatant covert harassment with people who do not respect the law.

My health has declined due to new tumor growth caused by excessive walking and stress. For the first time in my life, I have 75 percent foot paralysis. This has decreased my ability to get out and engage in life.

As a result, I find myself not only alone to deal with a crippling, life threatening disease, but I also lost my Medical insurance and have no money to see my specialist at UCSF in California, at \$750 a visit. Not only does Reno not have an oncologist that is familiar with my rare tumor, but the city of Reno, has denied me home care and rides to see the cancer specialist here, forcing me to take long bus trips and walk an excess of over an hour to see my oncologist.

Every member of my family, (except my brother), has been threatened or paid off, and have turned against me withdrawing any help to move me back to California to save my life. I believe that the very fact that I stay positive and determined to return to California is testament to my stable mental state of mind.

Date: 09/10/2019

First Name: [REDACTED]

Last Name: [REDACTED]

City: Atwater

US States: CA

Zip: 95301

Have you experienced coordinated stalking?

Our neighbors began spying. Strange vehicles park down the street for long periods of time in front of empty lot. Strangers want to become friends only to turn out as perpetrators gathering intel in order to influence old friends. Repeated strangers prowling with cellphones at the front door and backyard. Caregivers and medical professionals harassing us. Grocery store clerks making odd claims and remarks. Computers compromised rendering them unusable. Family members making odd assertions. Online harassment and sabotage during chat.

Have you reported coordinated stalking to law enforcement?

APS was called in Merced County.

FBI contacted from Calaveras County.

APS Mariposa County called.

Reported to Private security guard the parking lot stalking in the heart surgery center Fresno.

Have you moved because of coordinated stalking?

I moved from Merced County to Santa Cruz County.

Then from Santa Cruz County and Monterey County to Merced County.

Family then moved from Merced County to Calaveras County.

Father moved from Mariposa County to Calaveras County with us.

We then moved from Calaveras County to Merced County.

Have you been mis-diagnosed by mental health professionals?

Mother injured repeatedly in care facilities and in nurse and fireman-owned assisted living facility in Tuolumne County. She experienced severe neglect resulting in near death.

Same professionals relative to her case diagnosed me with anti-social personality disorder.

Resulting effects on your life:

Loss of family, many friends, and proper medical and dental care. Loss of proper home improvement hires who deliberately undermine and sabotage. Almost complete isolation of 21 years.

Date: 09/10/2019

First Name: [REDACTED]

Last Name: [REDACTED]

City: Daggett

US States: CA

Zip: 92327

Have you experienced coordinated stalking?

The coordinated stalking started on November 21, 2007. I had a BS degree from Cal State Univ. Long Beach, a fiancée, professional job making \$37 an hour, had mountain climbing records, was doing motivational speeches — and it all ended. It was nuts. My life ended as I knew it. It was upside down. It is overwhelming but with the grace of God, I survived and have been able to cope with these crimes and abuses. For me, people do not follow me but rather, they know my whereabouts using mobile devices, no matter how nuts that sounds. The abuses are so awful to me. It is break-ins to my car, home, planting felony drugs, vandalism, much more.

Have you reported coordinated stalking to law enforcement?

Of course, if I called the police for all the stalking and harassment, I might be calling them every day or more. I save those for civil actions. As far as calling law enforcement, I have called for home burglary, planting drugs twice, car burglary, vandalism, hit and runs while parked — three times, and assault and battery. I do have all the report numbers.

On February 14, 2017, I found what appeared to be crystal methamphetamine inside my small studio on a computer desk. After calling family and friends to validate the incident for self-protection, I called the Laguna Beach police (Report # [REDACTED] and Police Officer Kyle Milot said it could be a felony drug. There are many more police report numbers I can find upon follow up.

Have you moved because of coordinated stalking?

No, but I have moved to another county and the coordinated stalking continued. In the first 3 weeks, my car was vandalized. The sheriffs did not take the vandalism seriously. I filed a claim. On October 26, 2017, the Sheriff's department sent me a letter "Sustaining" my complaint, which means officer misconduct. I went to a county supervisor meeting and thanked them and said that I will not file a lawsuit. After that, the coordinated stalking lessened and the fact that I was less in a public area I feel contributed significantly to this.

Have you been mis-diagnosed by mental health professionals?

Yes. Then I discovered from a medical journal there is a medical scan to test and show the difference between "Normal vs. Schizophrenia Brains" for schizophrenia called a Positron Emission Tomography (PET) scan. So I had a PET scan performed by Dr. Jeffrey Dobkin, M.D. California License G-73366, Physician and Surgeon, registered with the State of California and taken at Long Beach PET Imaging Center, now Memorial Care Imaging Center, prescribed by Long Beach Memorial Care Medical Hospital, Long Beach, California. The finding and opinion was "Normal" brain of John Thomas Christiana. Report written by Dr. Jeffrey Dobkin, M.D.

This scan and report has been "Granted" into evidence in 2018 after a "Request for Judicial Notice" in Orange County Superior Court. And in addition, accepted as evidence in small claims court where I initially won a small claims case for defamation when defendant said I "need help" for discussing the coordinated stalking and related persecutions.

Resulting effects on your life:

There is no way any person not affected can understand. My life ended as I knew it. I had 20 straight years of professional management employment consisting of three employers. Now gone. Dating life ended. My 26 motivational talks to charities ended. Everything changes.

When you are subjected to the level of harassment and coordinated stalking that I am, normal life ends. All that matters is getting your freedom and life back. It has extensively and adversely affected my family and my elderly mother. My father died. It is an attack on freedom and a strain and drain on society. It encourages crimes and abuse to the participants and who knows what other crimes to women (most victims are women) and society they will do next.

Date: 10/20/2019

First Name: [REDACTED]

Last Name: [REDACTED]

City: Atwater

US States: CA

Zip: 95301

Have you experienced coordinated stalking?

Neighbors spying and harassment. Private utility company contracted harassment. Unidentified vehicles sitting outside home. Front and backyard intrusions.

Have you reported coordinated stalking to law enforcement?

No.

Have you moved because of coordinated stalking?

Yes.

From Calaveras County to Merced County.

Resulting effects on your life:

Increased expenses. Stress.

Date: 09/10/19

First Name: [REDACTED]

Last Name: [REDACTED]

City: Reno (Former California resident)

Zip Code:

I have been stalked and harassed by multiple persons in an organized fashion. I have been subjected to the following harassment:

- Stalking and or surveillance by multiple persons, most unknown to me (including some neighbors) on foot or in vehicles.
- Online bullying by more than one perpetrator.
- Electronic hacking and intercepting of communications.
- Workplace harassment /bullying /sabotage/slander
- Road bullying
- Noise Campaigns (yelling, taunting outside windows/doors of residence frequently - especially at night)
- Automobile break-ins.
- Loved ones being stalked and harassed.

Please tell us if you moved due to the stalking:

Yes, I have had to move from the SF Bay Area (East Bay - Richmond, Oakland, Berkeley) in CA, to Reno, NV due to coordinated stalking. At the time that I relocated, I had no idea what coordinated stalking was. I thought, at the time, that moving was the answer and unfortunately, I eventually started dealing with the exact same tactics in my new home of Reno, NV. I started to notice that the same things that were happening in CA were happening in NV. I am still currently being stalked and harassed.